

# International Conference on Space Optics—ICSO 2010

Rhodes Island, Greece

4–8 October 2010

*Edited by Errico Armandillo, Bruno Cugny,  
and Nikos Karafolas*

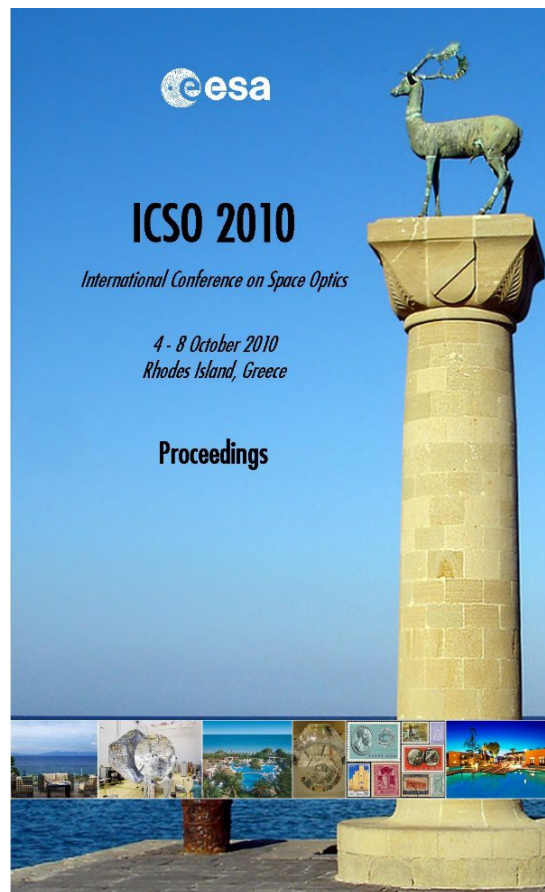

## ***Fiber-optic sensor demonstrator (FSD) preliminary test results on PROBA-2***

*Roman V. Kruzelecky, Jing Zou, Emile Haddad, Wes Jamroz, et al.*



International Conference on Space Optics — ICSO 2010, edited by Errico Armandillo, Bruno Cugny,  
Nikos Karafolas, Proc. of SPIE Vol. 10565, 1056516 · © 2010 ESA and CNES  
CCC code: 0277-786X/17/\$18 · doi: 10.1117/12.2309107

# FIBER-OPTIC SENSOR DEMONSTRATOR (FSD) PRELIMINARY TEST RESULTS ON PROBA-2

Roman V. Kruzelecky, Jing Zou, Emile Haddad and Wes Jamroz <sup>(a)</sup>,  
Francesco Ricci and Eric Edwards<sup>(2)</sup>,  
Iain McKenzie and Pierrick Vuilleumier<sup>(3)</sup>

<sup>(a)</sup> *MPB Communications Inc., Pointe Claire, Québec, H9W 1S2, [Roman.Kruzelecky@mpbc.ca](mailto:Roman.Kruzelecky@mpbc.ca);*

<sup>(b)</sup> *Xiphos Technologies Inc., Montreal, Québec,*

<sup>(c)</sup> *Optoelectronics Section, European Space Agency, Noordwijk, The Netherlands.*

## ABSTRACT

Fiber Sensor Demonstrator (FSD) developed by MPB Communications (MPBC) is the first demonstration of a full fiber-optic sensor network in the space environment on a satellite. FSD has been launched on ESA's Proba-2 satellite in November 2009. FSD contains twelve temperature sensors to measure the temperature at different locations in the satellite, and one High-Temperature sensor to measure the transient high temperature in the thruster, as well as one pressure sensor to measure the xenon tank pressure. First set of on-orbit test data were obtained in January 2010. The FSD unit successfully established the communication with Proba-2. The temperature of FSD unit was also acquired through a AD590 sensor inside the unit. The measurements of all the optical fiber sensor lines will be evaluated after the testing results obtained. The FSD contains twelve specially-packaged FBG temperature sensors to measure the temperature at different locations in the propulsion system and the spacecraft over the range of  $-60^{\circ}\text{C}$  to  $+120^{\circ}\text{C}$ . A high-temperature sensor is provided to measure the transient temperature response of the thruster to beyond  $350^{\circ}\text{C}$ . There is also an innovative P/T sensor that provides both temperature and pressure measurements of the Xe propellant tank. The preliminary data of on-orbit functional testing and temperature measurements are provided mainly in Section 6.

## 1. INTRODUCTION

This paper presents the preliminary results of the FSD system in-flight on Proba-2 after 10 months on-orbit. The FSD provides monitoring for various Proba-2 subsystems, including a hybrid propulsion system. It includes a redundant architecture developed for critical fiber-optic components, special sensors for the propulsion subsystem, and a lightweight, ruggedized fiber-optic signal harness for use in space.

Spacecraft systems require extensive "insitu" monitoring of their status and thermal performance,

both during ground validation and the subsequent operation in the space environment [1]. In particular, spacecraft propulsion subsystems [2] require an array of different sensors to monitor the propellant tank pressure and integrity, the gas-line valve temperatures and status, the propellant mass flow rate and the thruster temperatures. This is currently performed using various electronic sensors at a substantial mass and performance penalty due to the shielding requirements. The current electrical sensors have a number of drawbacks, including sensitivity to EMI, susceptibility to sparking, low sensor capacity per wire, sensor response times, and the proximity requirements for the associated electronics.

MPB Communications (MPBC) is developing solutions to the monitoring requirements of spacecraft based on its fiber-laser and Fiber Bragg Grating (FBG) expertise. A major application culminated in the Fiber Sensor Demonstrator (FSD) installed on ESA's Proba-2 that was launched in November 2009. This is the first demonstration of a full fiber-optic network in the space environment on a satellite. The advantages of the FBG approach include a central interrogation system that is used to control a variety of different fiber-optic sensors including temperature, pressure, actuator status, and propellant leakage. Using a combination of both parallel signal distribution and serial wavelength division sensor multiplexing along single strands of fiber enables high sensor capacities.

Fiber-optic sensors employ a signal link via an optical fiber, allowing the subsequent electronic processing to be located remotely from critical areas of the spacecraft. This facilitates minimization of electromagnetic interferences and avoids the safety issues associated with electronics near the propulsion subsystem. Signals on a fiber-optic line are bidirectional, allowing a single fiber to carry both the source signal to the optical sensor and the reflected return signal back to the interrogation system. Due to the low signal loss,  $< 1$  db/km, relatively long signal links are feasible with good signal integrity.

The MPBC fiber-sensor system employs fiber Bragg gratings that can be serially written into the core of the fiber. They are then specially mounted in a miniature package using MEMS techniques to enhance their sensitivity to the desired physical property and provide some environmental protection. As the sensor spectral characteristics are very precise measured with 1-2 pm resolution, very precise measurement is possible through the fiber-optic sensors.

The benefits of the fiber-optic sensor network include EMI insensitivity, remote positioning of the interrogation system, flexible signal routing using lightweight fiber-optic cables with microtubing armour for strength, high sensor capacity, and high measurement resolution of the sensor response.

## 2. SYSTEM OVERVIEW

A schematic of the FSD system is shown in fig. 1. The system features:

1. central interrogation system weighing under 1.2 kg and requiring less than 3.5 W peak power (fig. 2),
2. redundant RS422 link at 115,200 kbps to Proba-2 in master/slave operation,
3. six external fiber-optic I/O sensor lines with special sheathing and two internal reference lines.

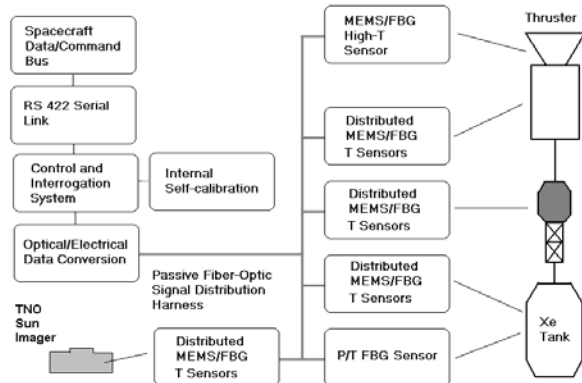

**Fig. 1: Block diagram of the Fiber-optic Sensor Demonstrator for Proba 2.**

The compact central interrogation system is only 12 x 70 x 150 mm in size (see fig. 2). The interrogation system is located remotely from the fiber sensors, at an opportune location in the Proba-2 spacecraft to optimize the usage of available space. The FSD electronics feature two electronic PCBs integrated on an Al support frame. The CPU PCB, as designed with Xiphos, features a fault-tolerant architecture with resettable latch-up protection, a FPGA microprocessor, and 768 kbytes of SRAM for the data storage. Dual EEPROMs enable updating the software during the flight. The FPGA processor will provide real-time analysis of the FBG sensor peak positions to significantly compress the FSD measurement raw data size for ground downlinks. The FSD power is

controlled using an optically-isolated digital control signal from Proba-2. With a warm-up time of only a few minutes, the FSD can be intermittently activated during the flight to further minimize power usage.



**Fig. 2: Photograph of the assembled representative FSD interrogation system.**

Fig. 3 shows the flight DAQ PCB. This is employing spacegrade and 883 milgrade components for the critical functions, including a 16 bit A/D converter and serial interface D/A drivers from Maxwell. To minimize the power consumption, micropower op amps are employed for the analog signal processing. The DAQ PCB includes the control/monitoring electronics for the tuneable fiber-laser diode pumps and filters, as well as eight fiber-coupled InGaAs detector channels with individual preamplifiers for the six external FBG sensor lines and two internal reference lines. The InGaAs detectors are specially mounted within an Al PCB support frame to provide additional radiation shielding.

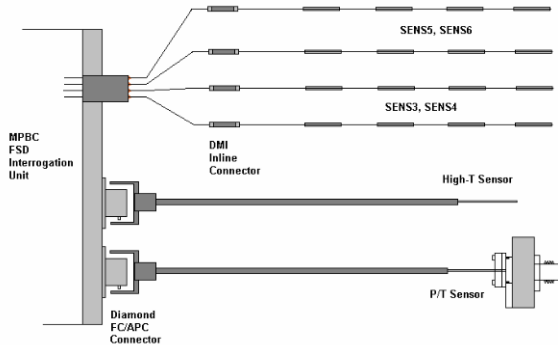

**Fig. 3: Photograph of the low-power flight DAQ (Data Acquisition) PCB.**

The analog circuitry also features a NMR RADFET circuit. It allows the measurement of the cumulative incident radiation to correlate the fiber-optic component performance with the space environment.

### 3. FIBER-OPTIC INTERFACE

The interrogation system employs a tuneable fiber-laser system operating between 1525 and 1560 nm to provide spectral measurement of the FBG sensors. The spectral resolution comparable to that of a laboratory wavemeter (1 to 2 pm), but with a much higher signal-to-noise ratio (SNR).



**Fig. 4: Schematic of FSD fiber-optic sensor signal harness.**

The FSD system provides six external fiber-optic I/O sensor lines (see fig. 4). Four of these are linked to provide back-up monitoring for the SSTL propulsion system on Proba-2. This includes separate fiber-optic signal lines with Diamond FC/APC connectors for the high-T thruster measurements and the P/T sensor that monitors the Xe propellant pressure. Additional Fiber-optic sensor lines (SENS3, SENS4) contain serially-multiplexed FBG sensors for measuring the temperature distribution at strategic points along the SSTL propellant pipeline. Two additional sensor lines (SENS5, SENS6) provide redundant measurements of other payloads on the Proba-2.

#### 3.1 FSD Fiber-optic Harness

The selection of the fiber-optic cabling is a critical issue due to the impact of the space environment on the optical fiber performance [3]. Fiber-optic cabling issues include:

1. Selection of vacuum compatible materials suitable for use to 350°C.
2. Mechanical protection for sections of fiber-optic cable in free space between mechanical attachment points on Proba-2.
3. Prevent fiber kinking during strong mechanical vibrations.
4. Dampen mechanical impact on silica core during vibrations.
5. Hermetic sealing of silica to minimize cracking due to stress corrosion effects associated with H<sub>2</sub>O and OH.

6. Operation with repeated thermal cycling between -40 and +70°C.
7. Robust but lightweight, flexible cabling.

For the FSD external fiber-optic cabling, a Cu-coated single-mode silica optical fiber was selected, (provided by Moscow Optical Fiber Technology Laboratory). The Cu-coated optical fibers exhibit much better hermetic sealing against moisture and superior tensile strength than standard telecom optical fibers. Moreover, they are usable to higher temperatures exceeding 500°C for harsh environment applications (melting point of Cu is about 1080°C). The proprietary MPBC cabling jacket includes additional layers for vibration dampening and mechanical strength to protect the Cu cladding and the fiber against abrasion and impact during mechanical vibrations and to prevent kinking during cable routing and attachment. The resultant cable has an O.D. of only 0.9 mm with a recommended minimum bend radius of 15 to 20 mm and a linear mass of under 0.3 gm/m.

Before the flight, the FSD fiber-optic cabling was space qualified at David Florid Laboratory in Canada, according to Proba-2 requirements. This included continuous vacuum thermal cycling between -20°C and 80°C for several days corresponding to about 100 cycles, and random vibration between 20 and 2000 Hz.

### 4. FSD SENSORS

This section describes the three innovative fiber-optic sensors for the FSD on Proba-2. The custom FBG gratings were manufactured using MPBC's proprietary clean-room FBG writing facilities.

#### 4.1 P/T Sensor

Fig. 5 shows a photograph of the P/T sensor integrated with Proba-2 propulsion subsystem. The P/T sensor employs a heat-treated, orbitally-welded stainless-steel housing that is suitable for direct contact with propellants such as hydrazine. It can be employed for either single-ended or differential pressure measurements. The P/T sensor was proof-tested in N<sub>2</sub> at 1200 psi, relative to the maximum operating pressure of 600 psi.

The FSD innovative P/T sensor uses multiple FBG gratings with special mounting to provide simultaneous pressure (P-sense) and temperature (T-sense) measurements. The pressure readings are independent of the gas composition (see Fig. 5). The integral temperature measurements are employed to correct for the effects of temperature on the pressure readings.



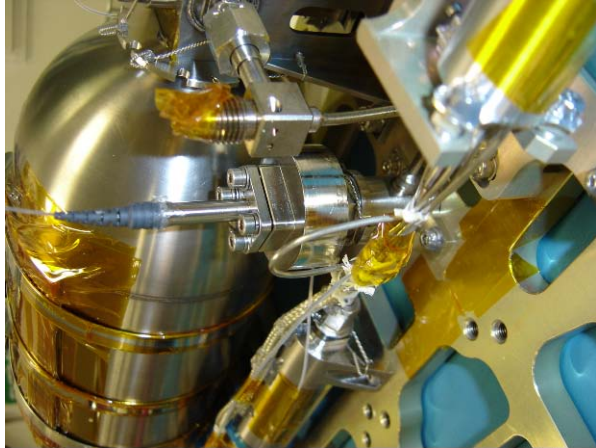

**Fig. 5: Photograph of flight P/T sensor integrated with the SSTL propulsion system for Proba-2.**

The P-sensor response to the applied pressure is very linear with minimal hysteresis comparable to the reference pressure measurement accuracy (see fig. 6). The temperature-compensated maximum hysteresis was about +/-0.015 nm relative to a full scale FBG center wavelength shift of about 12.75 nm for 600 psi. The T-sensor response is totally isolated from the pressure effects.

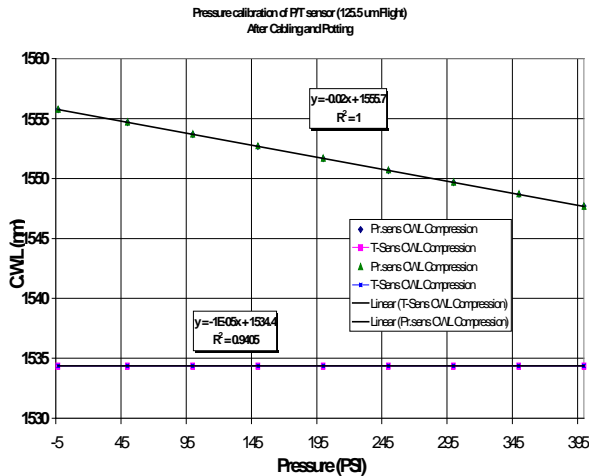
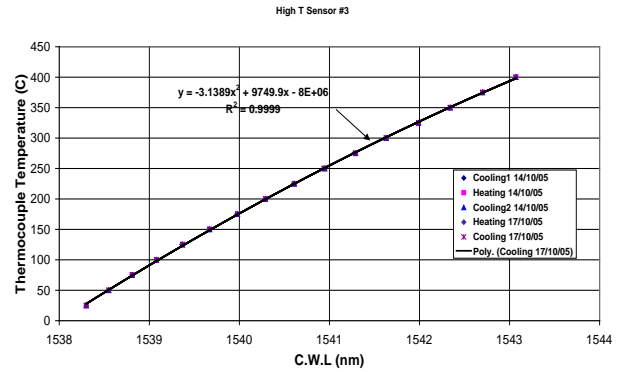

**Fig. 6: Response of the P/T pressure-sensing and temperature sensing FBGs to the applied pressure.**

### 5.2 High-T Sensor

The FBG fabrication for the high-T sensor entailed the development of special writing and processing steps to provide the sensor stability at higher operating temperatures. The high-T sensors employ a microtubing tip that is only 0.34 mm O.D. for minimal thermal mass relative to the standard thermocouples that employ a s.s. sheathing of several mm. It will be employed to measure the transient response of the SSTL thruster during firing.

Fig. 8 shows the calibration characteristics of a packaged high-T sensor. The sensor was subjected to repeated thermal cycling in air to 400°C. As shown, the resultant characteristic with temperature was similar to the initial calibration curve, providing very stable performance. The mounting of the High-T sensor within the special microcabling also mechanically decouples the FBG sensor from the sensor tip mounting, allowing robust integration with structures that does not affect the sensor calibration



**Fig. 7: High-T sensor calibration after repeated thermal cycling.**

### 4.3 Distributed FBG Sensors

One of the challenges with using FBGs for temperature measurements is that the grating central wavelength is sensitive to both temperature and strain. A special proprietary packaging was developed that nearly triples the effective sensor sensitivity to temperature ( $\Delta\lambda/\Delta T \cong 0.03 \text{ nm}/^\circ\text{C}$ ), as shown in fig. 8, relative to the sensitivity of the bare FBG (about  $0.013 \text{ nm}/^\circ\text{C}$ ) for improved measurement accuracy. The special packaging also decouples the FBG grating from the sensor mounting and surface strain. This enables good thermal contact while maintaining the FBG sensor calibration.

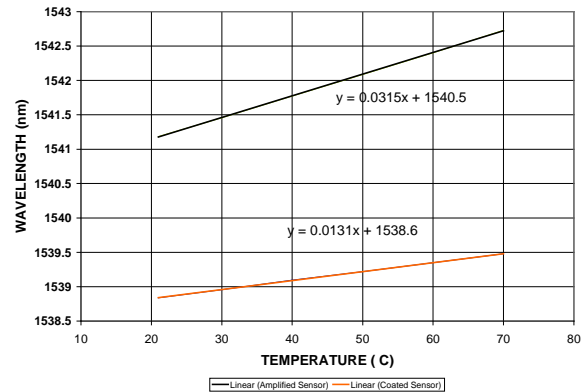

**Fig. 8: Measured temperature response of bare FBG (red curve) and packaged FBG with MEMS-amplified thermal sensitivity (dark curve).**

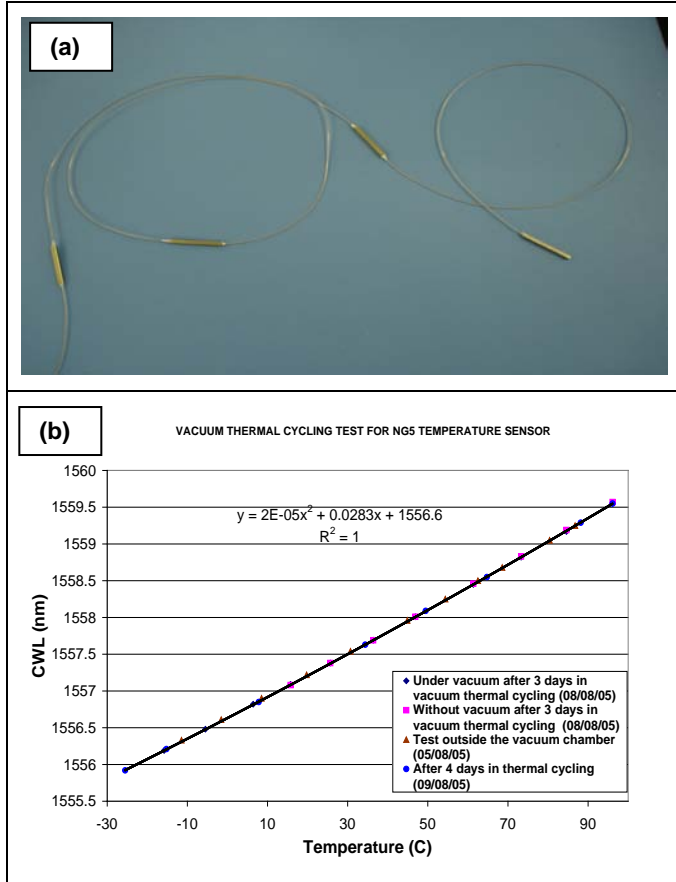

**Fig. 9: (a) photograph of a packaged flight FBG T-sensor line with protective cabling and four sensors, (b) test results for one of the FSD FBG T-sensors.**

Fig. 9a shows a cabled FBG T-sensor line for the FSD flight unit with four packaged FBG sensors. Each of the sensors operates over a different band of optical wavelengths. A bandwidth of 5 nm was provided for each sensor to avoid any possibility of a spectral overlap between adjacent sensors under worst case conditions. Fig 9b summarizes the FBG T-sensor resultant wavelength versus temperature characteristic after extended repeated vacuum thermal cycling for about four days in total. The sensor was continuously thermally cycled between  $-20^{\circ}\text{C}$  and  $+80^{\circ}\text{C}$  in a vacuum of about  $10^{-5}$  Torr with approximately one cycle per 30 min. Relative to the characteristics of the “as prepared” FBG gratings, the new sensor packaging and mounting methodology resulted in a nearly identical FBG center wavelength characteristic in vacuum at  $10^{-5}$  Torr. As indicated by the experimental measurements, the overall T-sensor mounting and calibration characteristic can be very stable in the vacuum environment after extended thermal vacuum cycling.

## 5. TESTING AND INTEGRATION ON PROBA2

The FSD technology demonstrator has been designed to showcase the overall advantages of MPBC’s innovative fiber-optic sensor technologies for space systems:

- compact ( $<1.2$  kg), low-power ( $<3.5$  W peak) central interrogation method with 1-2 pm spectral resolution and integral redundancy that can be used for different sensor types: pressure, temperature, valve status, propellant leakage,
- interrogation of both Fabry-Perot and FBG sensor types,
- parallel, redundant systems architecture with high measurement SNR to enable extended operation in space,
- remote placement of interrogation system from sensors at an opportune location,
- innovative lightweight ( $<0.3$  g/m), but ruggedized, fiber-optic signal harness,
- WDM multiplexing of sensors along a single strand of optical fiber for high sensor capacities,
- innovative FBG-based sensor designs with stable calibration, that are ruggedized for the launch vibration levels and extended thermal cycling encountered in the Proba-2 low-Earth orbit.

**Table 1: Specifications of the FSD Sensors.**

Sensor	Description	Range	Wavelength Span	Resolution
MEMS/FBG Temperature	Pipeline temperature / propulsion system	-40 to 70 °C	5 nm per sensor	0.05 °C
Combined pressure/temperature sensor	Xe Tank pressure	0 to 45 Bar	15 nm	2 mbar
		-40 to 70°C	5 nm	0.05 °C
High-T FBG sensor	Thruster temperature	-40 to 350°C	10 nm	0.1 to 0.2°C

The basic FSD experiment aims to examine the performance of the various fiber-optic and electro-optic components in the space environment as a function of the time spent in orbit and the radiation dose received. It will also be applied to study transient characteristics during spacecraft manoeuvres and the SSTL thrusters firing.

The FSD Flight Unit testing was accomplished at CSA’s David Florida laboratories at in Ottawa, Ontario. The initial testing included:

1. low-level 5 to 2000 Hz sine test for resonances,
2. random sinoisoidal vibrations at 16.3 grms,
3. system operation in thermal vacuum between  $-40$  and  $+60^{\circ}\text{C}$ .

The optical tray and mounted components exhibited no undue resonances between 20 Hz and about 2000 Hz. The fiber laser system was fully functional after the high-level random sine vibration test. The only slight resonance of note was near 800 Hz for the electronics PCB assembly, mainly at the DC-DC converter that was unstrapped for the initial random vibration testing. Representative high-T, FBG T sense and the flight P/T sensor cables assemblies were shipped to SSTL and integrated with the Proba-2 propulsion subsystem.

The representative sensors, integrated with the SSTL propulsion system, successfully underwent the random vibration testing to the Proba-2 levels. Optical signal testing after the completion of the random vibration test indicated negligible change in the return signal level intensities for sensors indicating that the fiber-optic sensors are capable of withstanding the typical launch vibrations (see Figs 10, 11 and 12).

The FSD system functionality, as received at Verhaert, was checked out by the MBP engineers. The FSD integration with Proba-2 was conducted with the expert assistance of Verhaert.

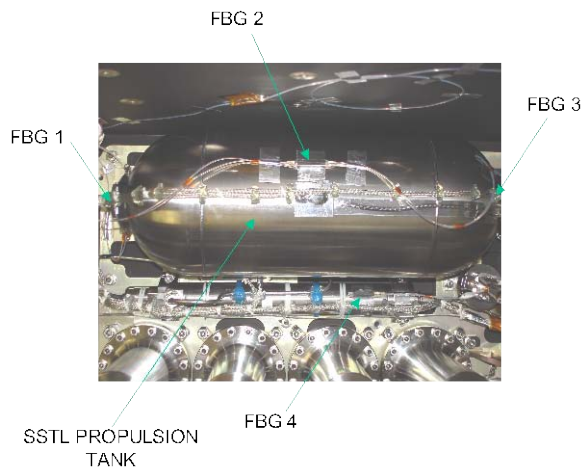

**Fig.10: FBG Sensors integrated with SSTL Propulsion Subsystem.**

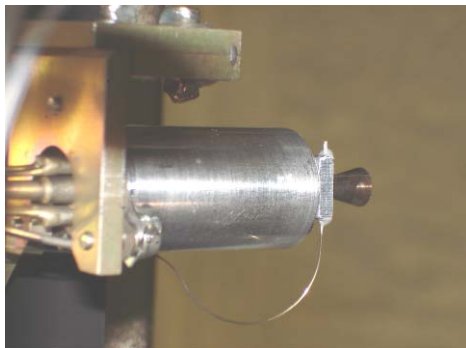

**Fig. 11: FBG Sensors integrated with SSTL Propulsion Subsystem.**



**Fig.12: P/T and HT sensors mounting on Proba2.**

The FSD employs a redundant temperature-compensated narrow-band reference FBG in series with the external FBG sensors (see fig. 9) for each of the six sensor lines to provide an absolute wavelength reference. The temperature dependence of the reference FBG's is about 0.001 nm/C.

## 6. ON ORBIT PRELIMINARY FUNCTIONAL TESTS AND MEASUREMENTS

Preliminary functional testing and measurements were downloaded by Verhaert/SSTL.

Table 2 summarizes the return signal of the major components of the FSD, confirming their functionality. The temperature of the reference FBG holder is monitored using two AD590 thermistors. This is used to correct for any potential slight wavelength shift of the reference FBG's with local temperature.

All the 13 signals used to monitor the FSD are fully functional. The AD590 and the laser diode temperature are very close. The return signals of the various applied voltage are correct.

MPB will monitor periodically the performance of fiber laser and the FBG sensors over time on a weekly basis. The FSD unit will measure Proba-2 temperature variations in increments over an orbit, when requested by Verhaert or ESA. The FSD is providing supplementary monitoring of the Proba-2 propulsion subsystem.

**Table 2: FSD Preliminary orbit test results.**

Chan nel	Signal Description	Unit	Measurements	
			1st run	2nd run
6	AD590_1 (Electronic T-sensor)	°C	22.2	22.2
7	RADFET (X-rays) (2.2 on ground)	V	2.02	2.02
8	FFP_1 (Fixed Fabry Perot)	V	Fig	NA
11	AD590_2 (Electronic T-sensor)	°C	21.7	21.7
12	PLD1 (Power of laser diode1, Functional over threshold)	V	5.43	5.43
13	TLD1 (Temp of laser diode1, Functional +TEC cooler)	V	1.12V (22°C)	1.12V (22°C)
14	PLD2 (Power of laser diode2, Laser Diode 2 is off)	V	0	0
15	TLD2 (Temp of laser diode2-Off)	V	0.94 (25°C)	0.94 (25°C)
16	FP_BIAS_1 (Functional)	V	-2.4V	-2.4V
17	FP_BIAS_2 (Functional)	V	-10V	-10V
18	+5V_Monitor (Test that return ½ value)	V	2.4 (x2)	2.4 (x2)
19	+12V_Monitor (Test that return ½ value)	V	6.16 (x2)	6.16 (x2)
20	-12V_Monitor (Test that return ½ value)	V	-6.22 (x2)	-6.22 (x2)

Fig. 13 compares the signal of the Fixed Fabry-Perot Interferometer preliminary data, after 10 months on-orbit, with the intensity after integration on Proba-2, before the launch. In both cases the signal Intensity is 2.5 Volts similar to that before the launch. The width of a single scan of the Fabry Perot on orbit is very similar to that on ground.

The fixed Fabry-Perot interferometer is the basic component to measure the wavelength of the FBGs, it is accuracy is a good sign of the sensor functionality in space.

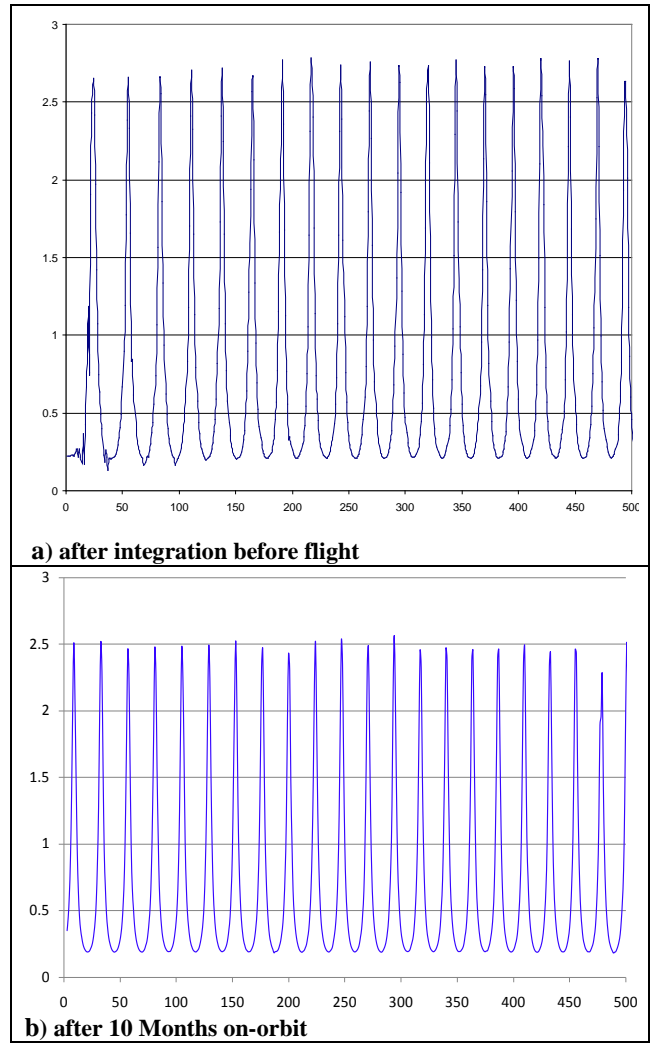

**Fig. 13 : Fixed Fabry-Perot signal a) before the flight and b) after 10 Months on orbit.**

Fig. 14 illustrates the signal of the FBGs Line TS003 on ground after integration on Proba-2 and after 10 months on-orbit. The MPBC interrogation system provides a high measurement SNR ( $> 10^4$ ) that can accommodate a relatively large signal intensity decrease exceeding an order of magnitude at the sensor system end-of-life (EOL). This large margin should facilitate high performance for extended duration space missions.

Due to a short delay time in the data transfer, the data downloaded is missing the reference peak and first peak raw data. This situation was corrected

The processed data of the three last sensors (peaks) are presented in Fig.14b) We can note that the signal intensity did not change over the 10 Months on orbit.



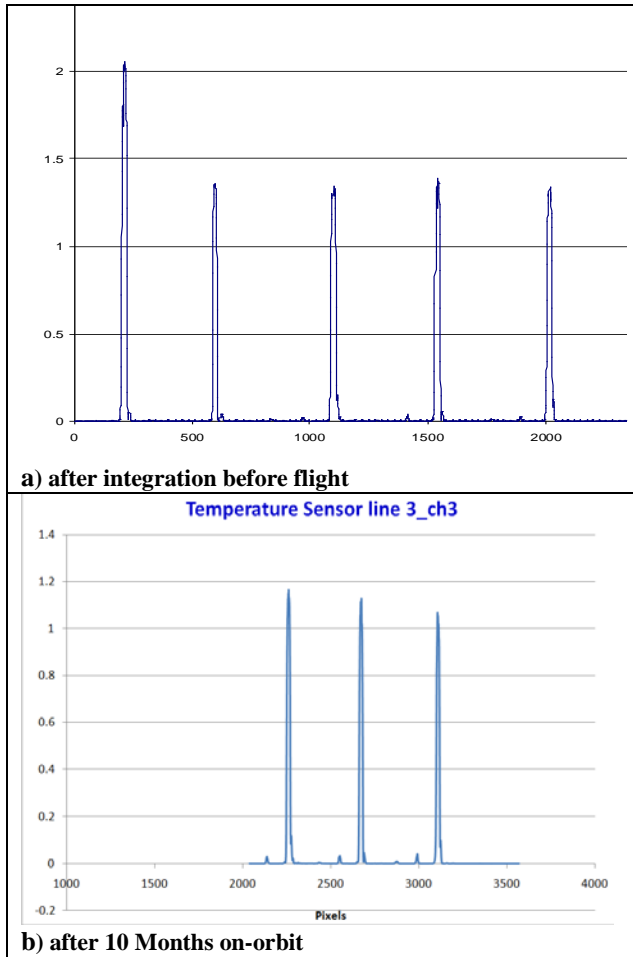

**Fig.14: Readout scan of installed sensor line TS-003  
a) on ground and b) after 10 months on-orbit.**

Recent downloaded data includes the response of the High Temperature sensor on the thruster and the P/T Fiber sensor on the Xenon tank. These data are being analysed and will be presented in future work.

## 7. CONCLUSIONS

Spacecraft require extensive “insitu” monitoring of their status and thermal performance, both during ground validation and the subsequent mission in the space environment. This is currently performed using an ad hoc assembly of various electronic sensors and processing electronics at a substantial mass and performance penalty due to the EMI sensitivity and resultant shielding requirements.

MPB Communications is developing solutions to the monitoring requirements of spacecraft based on its fiber-laser and Fiber Bragg Grating (FBG) expertise. The FSD for ESA’s Proba-2 is the first demonstration of a full fiber-optic sensor network in the space

environment on a satellite. The FSD design incorporates both adaptations of standard fiber-optic components as well as custom-designed sensors and fiber-optic cabling to meet the requirements of operation in space and the monitoring needs of spacecraft propulsion systems:

- RS422 Communication is established successfully between FSD and Proba 2
- The temperature reading from temperature sensor AD590 is acquired by the FSD 16 bit A/D converter
- Fabry Perot Interferometer line is operational
- Fiber line is operational
- No degradation of the fiber –optic signal levels after 10 Months
- Successful power up/down of fiber laser
- Flight experiment and data analysis ongoing
- Next step to download all lines after establishing the optimal time delay, including High temperature sensor on the thruster and pressure sensor

## 8. ACKNOWLEDGEMENTS

The authors would like to gratefully acknowledge the assistance of Darius Nikanpour, Stephane Lapensee, and Yvan Soucy from the Canadian Space Agency, Daniel Levesque, currently at ESA, as well as the support of CSA and ESA for this work. The authors would also like to thank Sanjay Mistry and SSTL for their support, patience and assistance with the integration of the FSD sensors with the SSTL propulsion subsystem for Proba-2.

## 9. REFERENCES

1. I. McKenzie and N. Karafolas, “Fiber Optic Sensing in Space Structures: The Experience of the European Space Agency,” OFS, 2005.
2. R. Brandt; “Design and development status of European propellant gauging devices and techniques”; Proceedings of the Spacecraft Propulsion international conferences organised by ESA and CNES, Toulouse, France, 8-10, Nov. 1994.
3. M. Ott, “Technology Validation of Optical Fiber Cables for Space Flight Environments” SPIE Conference Proceedings Vol. 4216, Optical Devices for Fiber Communication II, Boston MA, 2000.