

# International Conference on Space Optics—ICSO 2012

Ajaccio, Corse

9–12 October 2012

*Edited by Bruno Cugny, Errico Armandillo, and Nikos Karafolas*



## *The SiC hardware of the Sentinel-2 multi spectral instrument*

*Michel Bougoin*

*Jérôme Lavenac*



# The SiC hardware of the Sentinel-2 Multi Spectral Instrument

Michel Bougoin & Jérôme LAVENAC  
Boostec (a company of Mersen group)  
Bazet, France

[michel.bougoin@mersen.com](mailto:michel.bougoin@mersen.com)  
[jerome.lavenac@mersen.com](mailto:jerome.lavenac@mersen.com)

**Abstract**— The Sentinel-2 mission is a major part of the GMES (Global Monitoring for Environment and Security) program which has been set up by the European Union, on a joint initiative with the European Space Agency. A pair of identical satellites will observe the earth from a sun-synchronous orbit at 786 km altitude.

Astrium is the prime contractor of the satellites and their payload. The MultiSpectral Instrument features a “all-SiC” TMA (Three Mirror Anastigmat) telescope. MSI will provide optical images in 13 spectral bands, in the visible and also the near infra-red range, with a 10 to 60 m resolution and a 290 km wide swath.

The Boostec® SiC material is used mainly for its high specific stiffness (Young's modulus / density) and its high thermal stability (thermal conductivity / coefficient of thermal expansion) which allow to reduce the distortions induced by thermo-elastic stresses. Its high mechanical properties as well as the relevant technology enable to make not only the mirrors but also the structure which holds them and the elements of the focal plane (including some detectors packaging).

Due to the required large size, accuracy and shape complexity, developing and manufacturing some of these SiC parts required innovative manufacturing approach. It is reviewed in the present paper.

**Index Terms**— Ceramic material, SiC, Sentinel-2, space telescope, mirror, stable structure, focal plane

## I. INTRODUCTION

The Boostec SiC technology has turned out to be indispensable for manufacturing the highly stable >1 – meter class optics of HERSCHEL [1], GAIA [2] [3] and more recently SENTINEL-2 [4] [5]; all of them are missions of ESA. These instruments have been designed by ASTRIUM France with all in SiC concept; the mirrors are made of SiC but also the stable structure and the focal plane hardware as well. The SiC parts of the Sentinel-2 Multi Spectral Instrument (MSI) have been manufactured at BOOSTEC premises in the 2009-2011 time schedule. All mirrors have

then been polished, coated and supplied to Astrium by the company Amos. Astrium Toulouse team has fully achieved the integration of both SWIR and VNIR focal planes; it is now pursuing the integration of the 1<sup>st</sup> MSI Flight Model in view of a launch by end 2013. The SiC material properties are reviewed in the present paper and the manufacturing technology is further described. It includes i) manufacturing up to 1.5 meter monolithic SiC parts and ii) assembly of a large main structure with a brazing process. The MSI is made of 17 different SiC elements; the innovative SiC parts of SENTINEL-2 MSI instrument are presented in this paper.

## II. BOOSTEC® SiC MATERIAL

Boostec manufactures a **sintered silicon carbide** which is named **Boostec® SiC**. Its key properties are a high specific stiffness (420GPa / 3.15g.cm<sup>-3</sup>) combined with a high thermal stability (180W.m<sup>-1</sup>.K<sup>-1</sup> / 2.2 . 10<sup>-6</sup> K<sup>-1</sup>).

Its high mechanical strength allows making structural parts.

Thanks to its isotropic microstructure, the physical properties of this alpha type SiC are perfectly isotropic and reproducible inside a same large part or from batch to batch. In particular, no CTE mismatch has been measurable, with accuracy in the range of 10<sup>-9</sup> K<sup>-1</sup>; this is not the case of all SiC material candidates for space application [6].

TABLE I. BASIC PROPERTIES OF BOOSTEC® SiC

Properties	Typical Values @ 293 K
Density	3.15 g.cm <sup>-3</sup>
Young's modulus	420 GPa
Bending strength / Weibull modulus (coaxial double ring bending test)	400 MPa / 11
Poisson's ratio	0.17
Toughness (K <sub>1C</sub> )	3.5 MPa.m <sup>1/2</sup>
Coefficient of Thermal Expansion (CTE)	2.2 . 10 <sup>-6</sup> K <sup>-1</sup>
Thermal Conductivity	180 W.m <sup>-1</sup> .K <sup>-1</sup>
Electrical conductivity	10 <sup>5</sup> Ω.m

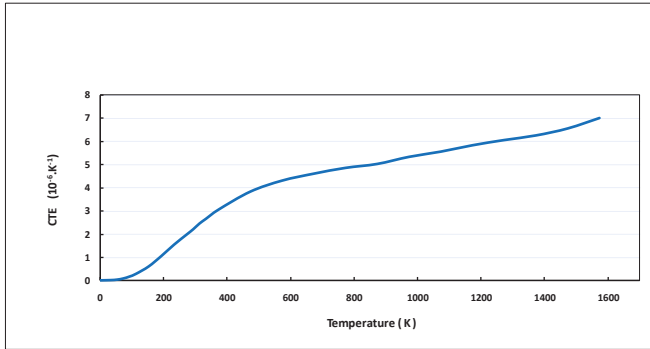

Fig. 1. Coefficient of Thermal Expansion of Boostec® SiC vs temperature

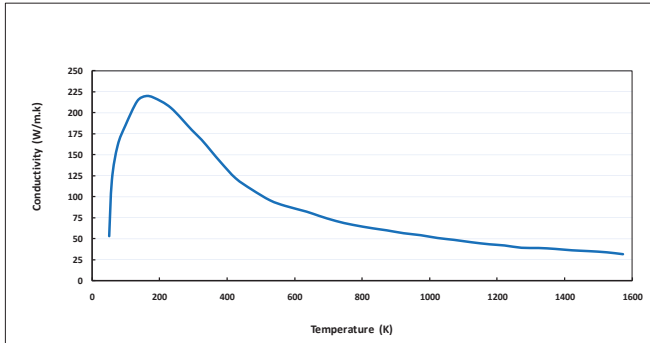

Fig. 2. Thermal Conductivity of Boostec® SiC versus temperature

The CTE of Boostec® SiC is decreasing from  $2.2 \cdot 10^{-6} \text{ K}^{-1}$  @ room temperature down to  $0.2 \cdot 10^{-6} \text{ K}^{-1}$  @ 100K and close to zero between 0 and 35K (Fig.1). Its thermal conductivity remains over 150 W/m.K in the 70K-360K temperature range (Fig.2).

This material shows no mechanical fatigue, no outgassing and no moisture absorption nor release. It has been fully qualified for space application at cryogenic temperature such as NIRSPEC instrument which will be operated at only 30K [7].

It shows a better stability in time and a better resistance to the space radiations than the glass-ceramics which have been commonly used up to now for the space mirrors.

The Boostec® SiC can be easily polished as it is single phased. Thanks to its high purity, its coefficient of thermal expansion (CTE) fits very well with the one of the extremely pure CVD SiC; this last one is obtained from chemical vapor deposition and it is commonly applied on the optical faces of SiC mirrors, in the aim to mask the few remaining porosities, when necessary.

### III. BOOSTEC® SiC MANUFACTURING TECHNOLOGY

#### A. Manufacturing monolithic SiC parts

Commonly, BOOSTEC manufactures monolithic SiC parts of up to 1.7m x 1.2m x 0.6m (or  $\Phi 1.25$  m). The flight models are manufactured with the sequence of steps shown in Fig. 3. The parts are machined very close to the final shape at the green stage i.e. when the material is still very

soft (similar to chalk). This is high speed machining; typically, green parts of 1 meter are machined within 1 week while lightweighting such a glass-ceramic blank should take several months. Furthermore, in BOOSTEC process, the collected chips are reused for producing new raw material. During the last ten years, the reliability and also the speed of this process have been continuously improved. New software has been invested for programming the CNC milling machines and also to verify the machining programs, thus allowing the green machining of very complex 3D shapes with a high reliability. These are some of the reasons why BOOSTEC process is so cost effective, reliable and quick.

These shaped parts are then sintered by heating-up to around 2100°C under a protective atmosphere, thus transforming the compacted powder blank into a hard and stiff ceramic material. The “as-sintered” surfaces look highly smooth (typically Ra 0.4  $\mu\text{m}$ ); they can be used as is, without any sand blasting or any other rework. The optical faces of the mirrors and also the interfaces of the structures are then generally ground in order to obtain accurate shape (from 1  $\mu\text{m}$  up to 50  $\mu\text{m}$ ) and location; they are optionally further lapped or polished for an even better accuracy and a smaller roughness.

The mechanically loaded parts are generally proof-tested in order to avoid defects which could be hidden in the material; even if unlikely, this is above all an easy way to really prove that the relevant SiC part is able to withstand with the predicted most critical loads. The parts are checked crack-free with help of UV fluorescent dye penetrant, before and after such a proof-test. They are measured with a large size accurate CMM or a laser tracker.

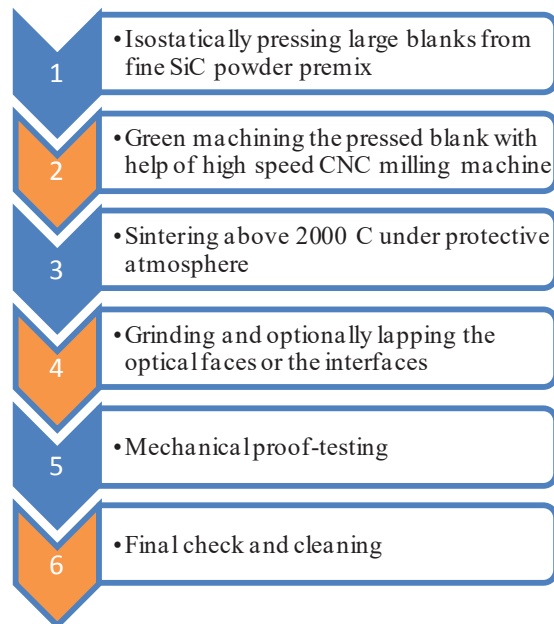

Fig. 3. Manufacturing process for monolithic sintered SiC parts

B. Manufacturing very large SiC parts

The SiC parts the size of which exceeds about 1.7m x 1.2m x 0.4m are obtained by **brazing** the assembly of previously sintered and ground pieces. The joint is made of a silicon alloy and it is generally less than 0.05 mm thick. The SiC parts are all joined together in a single run; their relative location is kept better than +/- 0.1 mm from the prediction to the final measurement, at the end of the brazing process. This process has been developed a decade ago for the  $\Phi$  3.5m Herschel primary mirror which is made of 12 SiC segments brazed together [1] [3]. Since that, it has been successfully used for the assembly of the  $\Phi$  3.0m Gaia torus [2] [3] and the main structure of Sentinel-2 MSI (§ V.D. here after). The brazed joints are checked with help of ultrasound technique which allows detecting possible braze voids down to a few mm<sup>2</sup>.

IV. THE SENTINEL-2 MULTI SPECTRAL INSTRUMENT

The Sentinel-2 mission is a major part of the GMES (Global Monitoring for Environment and Security) program which has been set up by the European Union, on a joint initiative with the European Space Agency. MSI will provide optical images in 13 spectral bands, in the visible and also the near infra-red range, with a unique combination of 10 to 60 m resolution and 290 km wide swath [4] [5].

Similarly as for the GAIA payload [2], the Boostec SiC technology turned out to be very helpful to reach the required thermo-mechanical stability. Then, the MultiSpectral Instrument which has been designed by Astrium features “all-SiC” large TMA (Three Mirror Anastigmat) telescope. It includes the following SiC hardware [4]:

- 3 aspheric mirrors (M1, M2 and M3),
- SWIR and VNIR focal planes hardware,
- A dichroic beam splitter holding structure,
- A large main structure.

The main characteristics of the telescope are the followings:

- Mass # 120 kg,
- 1<sup>st</sup> eigen frequency # 65 Hz,
- Operational stability: angular # 3  $\mu$ rad, WFE 20 nm and defocus 3  $\mu$ m.

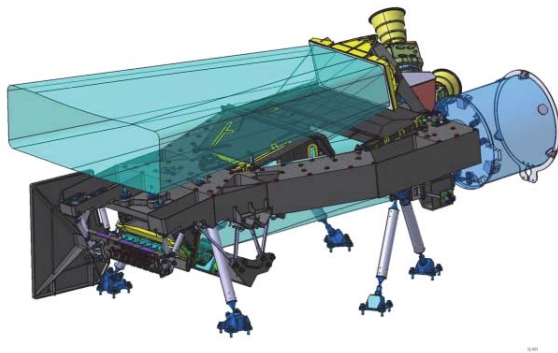

Fig. 4. Overview of the Sentinel-2 Multi Spectral Instrument (MSI)

V. SiC PARTS OF SENTINEL-2 MSI

A. The mirrors

TABLE II. MIRRORS CHARACTERISTICS

	Shape	Mounting	Size (mm)	Weight (kg)
M1	aspheric of-axis concave	central fixture at back side	442 x 190	2.3
M2	aspheric on-axis convex	central fixture at back side	147 x 118	0.3
M3	aspheric of-axis concave	glued bipods on outer edges	556 x 291	5.1

The entrance pupil is rectangular, equivalent to a  $\Phi$  150mm full pupil. The main characteristics of all 3 SiC mirrors are shown in Table II. The optical face of these mirror blanks have been ground by Boostec before and after CVD coating (i.e. before polishing), with a shape defect of few tens  $\mu$ m.

M1 and M2 are designed to be bolted directly on the main SiC structure. M3 is mounted on the same structure through glued bipods.



Fig. 5. M1 mirror blank



Fig. 6. M2 mirror blank

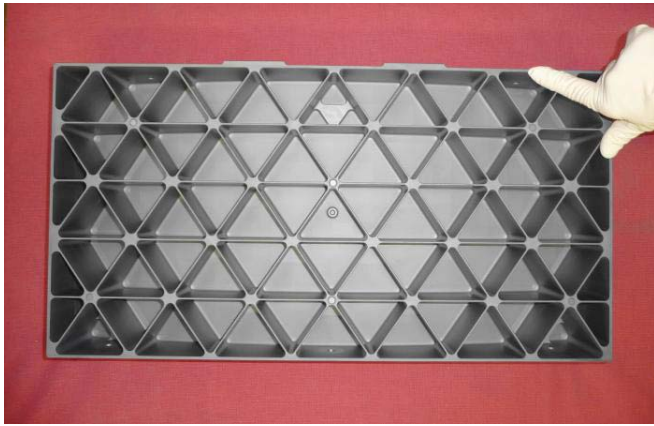

Fig. 7. M3 mirror blank (back side)

### B. The VNIR and SWIR focal planes hardware

A dichroic splits the beam towards two separate focal planes. The VNIR operates at 20°C and it uses Si CMOS detectors; the SWIR has HgCdTe ones which are individually mounted on small SiC substrates and operating at -80°C. All detectors are bolted on a SiC structure which also integrates a SiC panel acting as a radiator, thus allowing a passive cooling (bottom area of Fig.8 and left area of Fig.9). Then, ingeniously and efficiently, both functions of detectors support and radiator are implemented in a single SiC piece.

These structures are fixed to the main structure through 3 bolted bipods. The overall area where the detectors have to be bolted is lapped down to a flatness of 1µm.



Fig. 8. The SWIR detector support (5.4 kg)



Fig. 9. The VNIR detector support (3.6 kg)

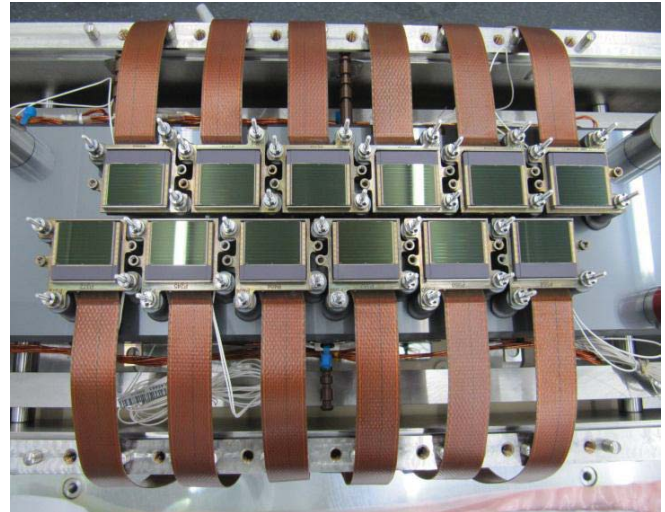

Fig. 10. Partial view of the VNIR focal plane including the detectors

### C. The dichroic beam splitter holding structure

This quite complex SiC part is bolted directly on the main structure. It holds the dichroic splitter through glued bipods.



Fig. 11. The dichroic beam splitter bracket (1.8 kg)

D. The main structure



Fig. 12. The main structure

The main structure of MSI holds the 3 mirrors, the beam splitter device, the 2 focal planes and 3 stellar sensors. It is furthermore mounted on the satellite through 3 bolted bipods. It has then a lot of interfaces which have been lapped in order to obtain the required flatness (down to 1  $\mu\text{m}$ ) and location (typically 0.1mm).

This main structure is sized 1.47m long x 0.93m wide x 0.62 m high and it weighs only 44kg. It is obtained by brazing the assembly of a base-plate with a M1 bracket and a M3 one, according to Fig.13 and § III.B. .

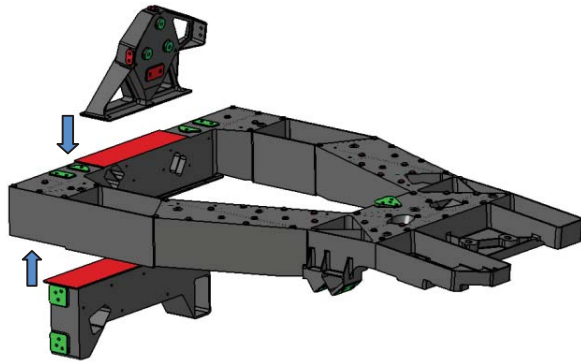

Fig. 13. The main structure is the brazed assembly of 3 monolithic SiC parts

E. Current status

The integration of the 1<sup>st</sup> Flight Model MSI is in progress in Astrium Toulouse premises. Both VNIR and SWIR focal planes have been fully achieved and the mirrors have been mounted and aligned on the main structure (Fig.14).

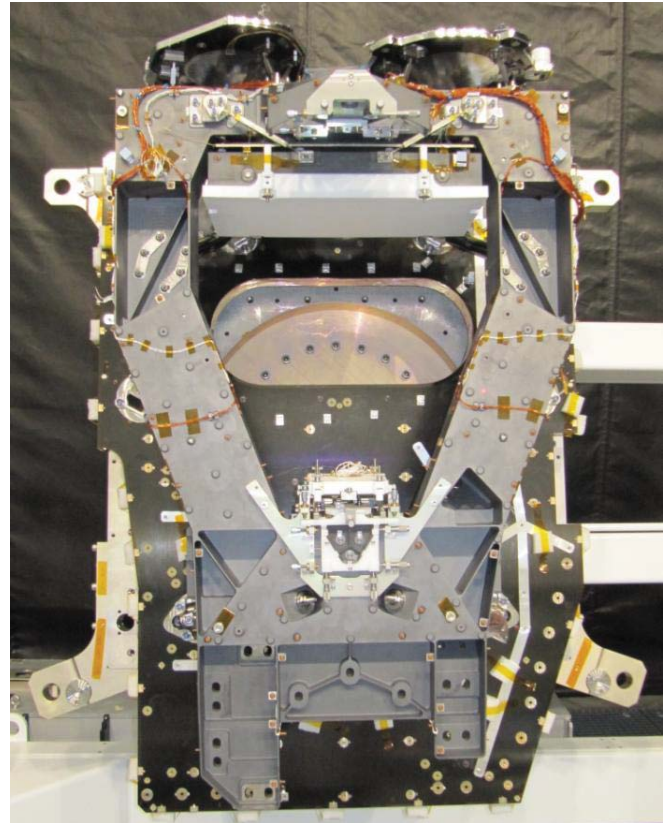

Fig. 14. The 1<sup>st</sup> Flight Model MSI being integrated in Astrium

VI. CONCLUSION

Seven all Boostec® SiC telescopes are now successfully operating in space, including the Herschel observatory which is the largest ever launched. Eleven others are being integrated in Astrium or waiting for launch. The 1<sup>st</sup> model Sentinel-2 MSI is one of those. This last instrument has again demonstrated that the Boostec® SiC technology allows making quite complex, large, innovative and highly stable parts or assemblies.

All these successful experiences clearly show that the pioneering time is behind Boostec team and that this technology is fully mature and ready for the future large space scientific and earth observation missions.

ACKNOWLEDGMENT

ESA ESTEC Sentinel-2 team and ASTRIMUM one have put their trust in BOOSTEC team for carrying out the innovative Sentinel-2 MSI project; we greatly appreciated.

We also express our warmest thanks to David Denaux (ASTRIUM) for his very constructive and fruitful collaboration on this project.

Images courtesy of ASTRIMUM and ESA

REFERENCES

- [1] Y Toulemon, T.Passvogel, G.Pillbrat, D. De Chambure, D.Pierot, D.Castel, « the 3.5m all SiC telescope for Herschel », Proceedings of the 5th International Conference on Space Optics (ICSO 2004), 30 March - 2 April 2004, Toulouse, France. Ed.: B. Warmbein. ESA SP-554, Noordwijk, Netherlands: ESA Publications Division, ISBN 92-9092-865-4, 2004, p. 341 – 348
- [2] P. Charvet, F. Chassat, F. SAFA and G. SARRI, “GAIA payload module description”, Sixth International Conference on Space Optics, Proceedings of ESA/CNES ICSO 2006, held 27-30 June 2006 at ESTEC, Noordwijk, The Netherlands. Edited by A. Wilson. ESA SP-621. European Space Agency, 2006.
- [3] M. Bougoin , J. Lavenac, “From HERSCHEL to GAIA, 3-meter class SiC space optics”, Optical Manufacturing and Testing IX. Edited by Burge, James H.; Föhnle, Oliver W.; Williamson, Ray. Proceedings of the SPIE, Volume 8126, (2011)
- [4] V. Cazaubiel, V. Chorvalli, C. Miesch, “The Multispectral Instrument of the Sentinel-2 Program,” Proceedings of the 7th ICSO (International Conference on Space Optics) 2008, Toulouse, France, Oct. 14-17, 2008
- [5] P. Martimort, M. Berger, B. Carnicero, U. Del Bello, V. Fernandez, F. Gascon P. Silvestrin, F. Spoto, O. Sy; “Sentinel-2, the optical high-resolution mission for GMES operational services ”, ESA Bulletin 13, August 2007
- [6] M. Bougoin, D. Castel, F. Levallois, “CTE homogeneity, isotropy and reproducibility in large parts made of sintered SiC”, Proceedings of ICSO 2012 (International Conference on Space Optics), Ajaccio, France, Oct. 9-12, 2012
- [7] K. Honnen, A. Kommer, B. Messerschmidt. & T. Wiehe, “NIRSpec OA development process of SiC components”, Advanced Optical and Mechanical Technologies in Telescopes and Instrumentation. Edited by Atad-Ettedgui, Eli; Lemke, Dietrich. Proceedings of the SPIE, Volume 7018, (2008). .