

International Conference on Space Optics—ICSO 2012

Ajaccio, Corse

9–12 October 2012

Edited by Bruno Cugny, Errico Armandillo, and Nikos Karafolas



Radhard optical patchcords and packaging for satellites using liquid crystal polymers

S. O'Riorden

A. Mahapatra



Radhard Optical Patchcords and Packaging for Satellites Using Liquid Crystal Polymers

S. O’Riorden and A. Mahapatra

Linden Photonics, Inc., USA

Abstract

There are many advantages to employing fiber optics for high capacity satellite communication. However, optical cables can be susceptible to high radiation, temperature extremes and vacuum environment. Any hardware used in these systems must be rugged, durable and immune to the detrimental effects of the aforementioned conditions.

Standard COTS optical fiber will darken when exposed to high levels of radiation limiting the effectiveness of the communications system. Of particular concern to satellites in GEO are energetic electrons, bursts of heavy particles due to solar storms which can cause total dose and single event effects (SEE). Conventional fiber optic cables have several issues performing in high radiation environments. Linden has patented and developed a novel cable using an extruded layer of Liquid Crystal Polymer (LCP) applied to commercially available fiber. Total dose effects are minimized by shielding with Liquid Crystal Polymer jacketing. It is a simple, inexpensive way to increase the radiation shielding and mechanical performance of cables in satellites while concomitantly providing hermeticity and thus increased fatigue factor for optical glass.

- LCPs exposed to 5000 Mrad dose of gamma rays retain in excess of 90 % of their mechanical properties.
- LCPs exposed to 1 Mrad radiation dose with energetic protons retain almost 100% of their mechanical strength. Tensile modulus increases with exposure to the radiation.

- Weight for weight the proton absorbing power of LCP is 25% better than that of aluminum.

We will present experimental data on radhard optical patchcords.

1. Introduction

There are many advantages to employing fiber optics for high capacity satellite communications; their reduced physical size, reduced weight, lower power consumption, greater bandwidth, better immunity from interference, and ability to effectively communicate with a higher number of satellites in any given orbital slot. However, optical cables can be susceptible to the rigors of the space environment – such as radiation, vibration, temperature extremes and vacuum environment. Linden has developed a novel radiation resistance, non-kink, optical cable (RAVNOC) that uses an extruded layer of Liquid Crystal Polymer (LCP) applied to commercially available radhard fiber. This cable has been tested successfully against rigorous European Space Agency – ESCC Basic Specification No. 2263010. This paper will describe construction of Linden’s RAVNOC, the properties of LCP properties and test results for RAVNOC.

2. Construction of Radiation Resistant, Non-kink, Optical Cable (RAVNOC)

Linden’s radhard optical cable uses a commercially available polyimide buffered radhard fiber, surrounded by extruded layers of liquid crystal polymer (LCP) and FEP as shown in Figure 1.

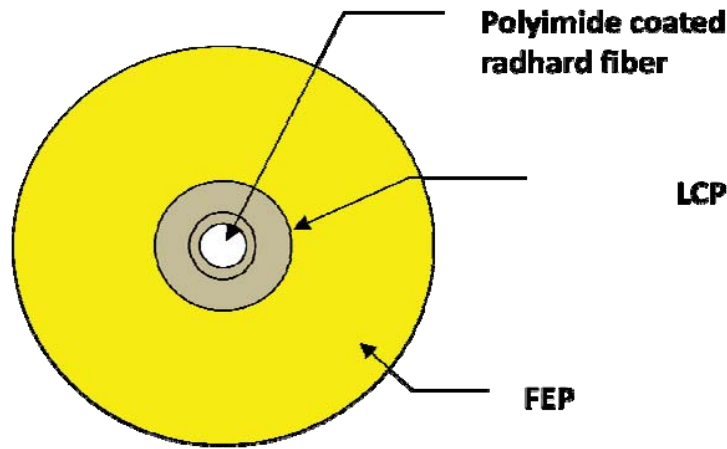

Figure 1. Design of RAVNOC

2.1. Choice of RadHard Optical Fiber

Most vendors that offer radhard optical fibers do not disclose their fiber designs but it is likely that they are mostly pure silica core fibers except for the fluorine doped core fiber which is available from Fujikura (Aikawa, 2008). A group at CERN, European Organization for Nuclear Research, Geneva, has performed a detailed radiation resistance comparison of several different commercially available optical fibers (De Jonge, 2008) the results of which are in Figure 2 and Fujikura's results are in Figure 3. General conclusions are as follows:

- Fluorine doped fibers from Fujikura Ltd show the lowest Radiation Induced Attenuation (RIA) < 2 dB/km at 1310 and 1550 nm after a total dose of 1 Mrad.
- Conventional Germanium doped fibers show RIA between 10 and 100 dB/km for same dose.
- Pure silica core fibers are available from several vendors and their RIA is in the range of 10 dB/km.
- RIA in Co-60 and HEP radiation fields are comparable.

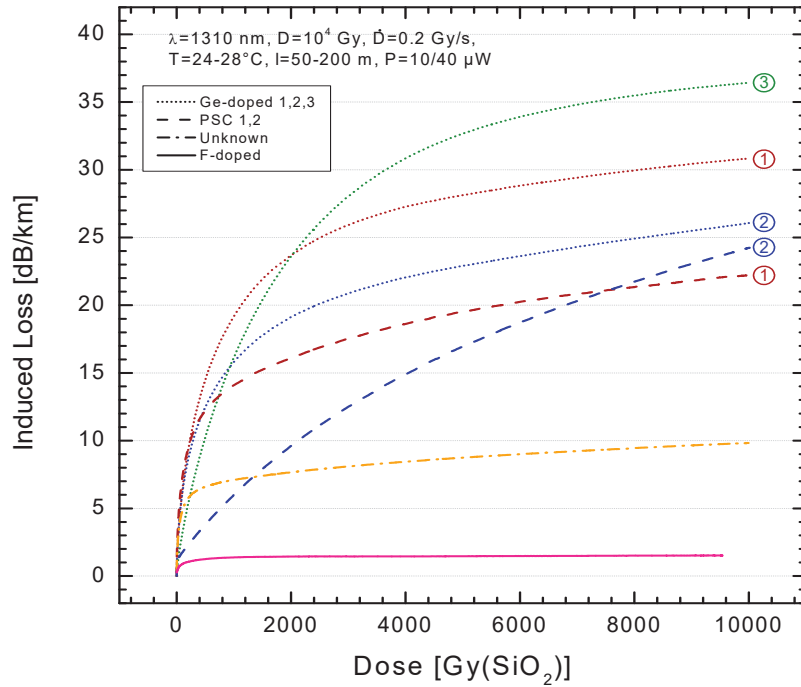

Figure 2. Radiation Induced Attenuation in Optical Fiber (1 gray = 100 rad)(De Jonge, 2008)

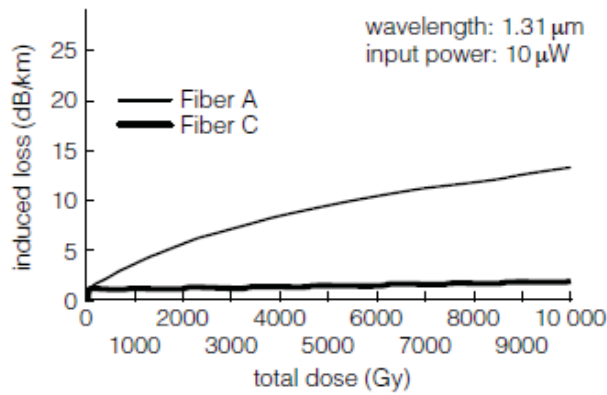

Figure 3. Radiation Induced Attenuation (RIA) in pure silica core (A) and fluorine doped core (C) optical fibers (Aikawa, 2008).

3. Liquid Crystal Polymer (LCP) Properties

3.1. Effect of Gamma Rays on LCP

The effect of gamma radiation on A950 LCP is documented by Ticona Corp and is reproduced in

Table 1. Clearly LCP will survive typical gamma radiation levels in space.

Table 1. Cobalt 60 gamma radiation, Vectra A950 LCP (Percentage retention of properties.) Source: Ticona technical literature

Radiation Dose	250 Mrads	1000 Mrads	2500 Mrads	5000 Mrads
Tensile Strength	97	95	95	95
Tensile Modulus	100	100	106	106
Break Elongation	81	81	79	79
Flexure Strength	101	102	102	102
Flexure Modulus	108	108	116	94

3.2. Mechanical Strength of Optical Cables after Irradiation

Linden Photonics, in conjunction with Auburn University and Gray Research, tested optical patchcords with LCP jacketing to test for strength before and after exposure. A Co-60 source was used and the samples were subjected to radiation at room temperature. The dose rate was measured with a calibrated dosimeter the day before testing began. Dose rate was measured at 81 rad(Si)/sec. The sample temperature was estimated to increase by ~10K above room temperature during exposure

due to gamma-ray heating. Exposure levels were 105, 262, 525, and 1050 krad(Si).

Mechanical measurements made included tensile strength and flexibility. We performed flex testing on samples to determine when the LCP layer would break and when the outside jacket layer would break. This was performed on a flex tester designed to SAE standard AS5382. As is shown in Figure 4, Figure 5, and Figure 6, there was no demonstrable decrease in tensile strength or flexibility with the increase in exposure.

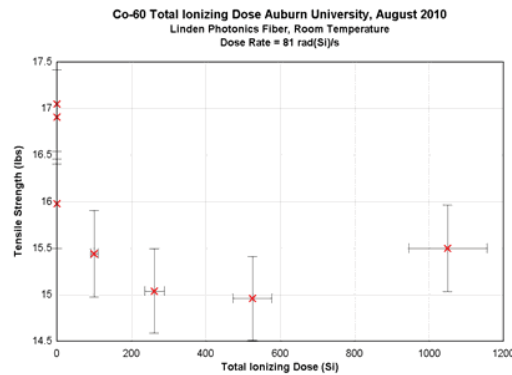

Figure 4. Tensile Strength vs. Dose

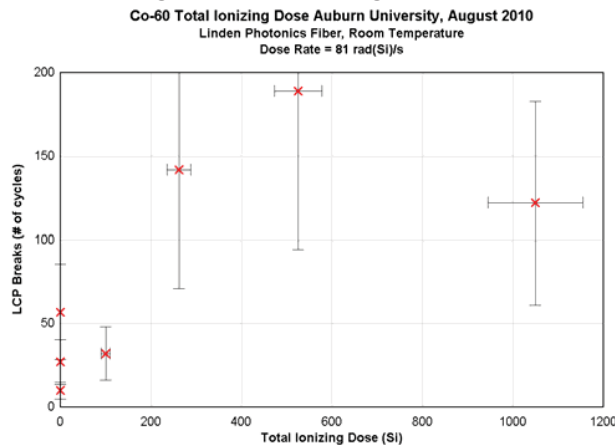

Figure 5. Flex Cycles till LCP Breakage vs. Dose

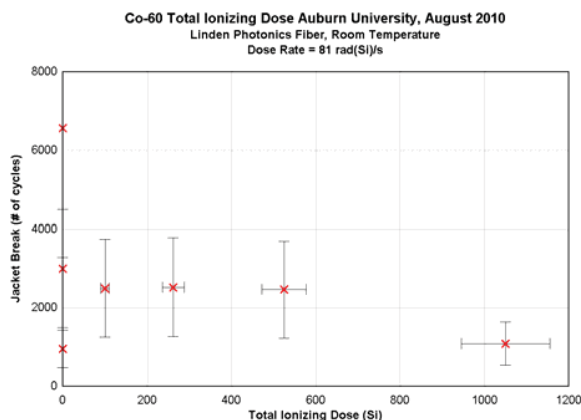

Figure 6. Flex Cycles till Outer Jacket Breakage vs. Dose

3.3. Range of Energetic Protons in LCPs.

We used programs developed by Dr. Barney Doyle at Sandia National Laboratory to calculate range of high energy protons in various materials. Results are summarized in Table 2.

Table 2. Range in Vectra LCP, copper and aluminum, as a function of proton energy.

Proton Energy, MeV	Fluence in MEO (#/cm ² /day, Barth, 1997)	Range in Vectra LCP (μm)	Range in copper (μm)	Range in aluminum (μm)	Range in PET (μm)
10	10 ⁹	1640	468	1127	1574
5	10 ¹⁰	468			
1	10 ¹²	29			
0.1	10 ¹³	1			

Obviously it is the highest energy protons that have the largest range. Note that the LCP has to be thicker by a factor of 3 than copper to stop 10 MeV protons. However, the density of LCP is much less. Hence a figure of merit, determined by the product

of density and range, can be used to determine the cost effectiveness of shielding. Table 1 shows the figure of merit for various materials. LCP figure of merit is better (lower) than aluminum.

Table 3. Figure of merit comparison of shielding strength.

Material	Range of 10 MeV protons (cm)	Density (gm/cm ³)	Figure of merit (gm/cm ²)
Vectra LCP	0.164	1.4	0.23
Copper	0.0468	8.96	0.42
Aluminum	0.1127	2.7	0.30

3.4. Moisture Barrier Properties of LCP Coated Optical Cable

It is one of the primary functions of the optical fiber coating that it prevents the ingress of water vapor, as the strength of the optical fiber deteriorates rapidly in the presence of moisture due to stress corrosion. All polymers are permeable to

water to some degree. The permeability is given by the product of the moisture diffusion coefficient D, and the solubility S, and is defined as the mass of water transmitted per unit area per unit time per unit of pressure for a given thickness of the polymer. LCPs, because of their rigid crystalline molecular orientation, exhibit the lowest levels of moisture permeability of any polymer. The relative

permeability of Vectra A950 LCP and a variety of other commonly used polymers is shown in Figure 7. Tensile strength retention of silica fiber

protected by hermetic carbon coating and LCP coating is compared in Figure 8.

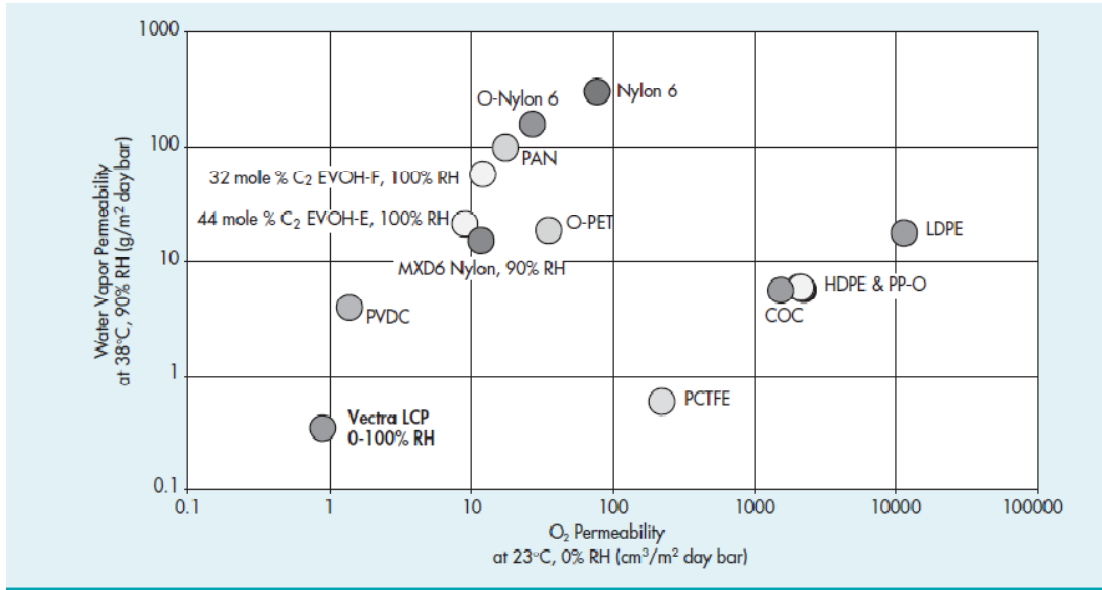

Figure 7. Permeability of various polymer films (25 μm thickness)

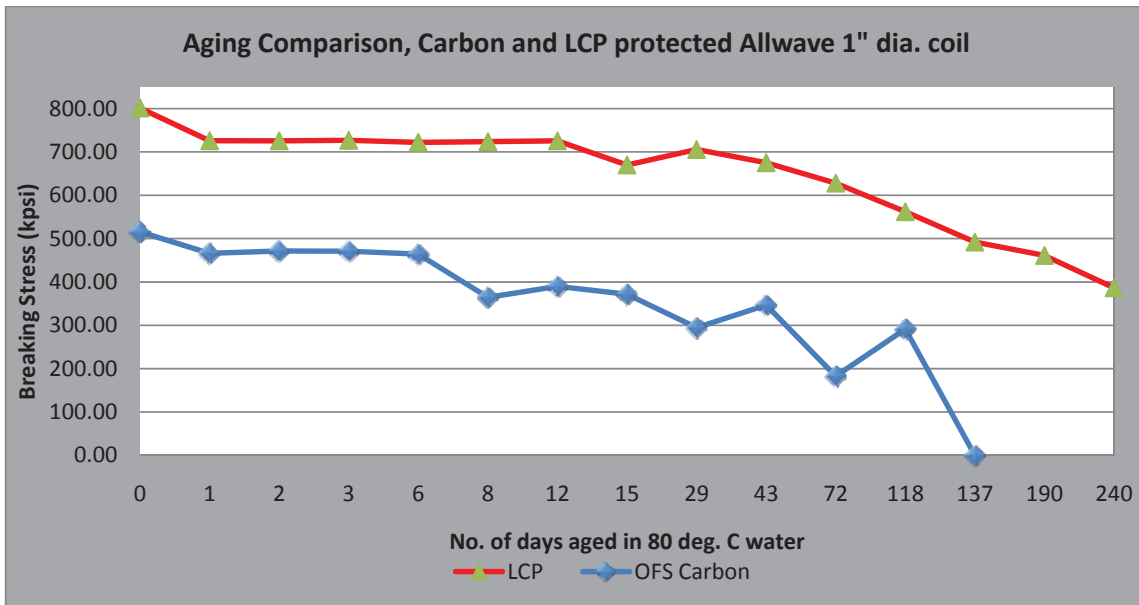

Figure 8. Moisture aging of carbon and LCP coated silica optical fiber

3.5. Strength and Modulus

The modulus, strength and other mechanical properties of LCPs are dependent upon the degree of molecular alignment, which in turn is influenced

by the manufacturing process. Table 4 shows the elastic modulus and ultimate tensile strength (UTS) of several filled and unfilled bulk materials produced by Ticona, under the trade name Vectra.

Table 4. Modulus and UTS of Vectra LCPs (Bulk)

Material	Type	Modulus Kpsi (Gpa)	UTS Kpsi (Mpa)
----------	------	--------------------	----------------

A950	Unfilled	1590 (10.6)	27.3 (182)
A230	30% Carbon Filled	3407 (23.5)	18.8 (130)
B130	30% Glass Filled	3190 (22)	30 (205)
B230	30% Carbon Filled	4611 (31.8)	29 (200)

The values given in the table are derived from measurements performed on bulk samples which have been produced by injection molding. In previous work with extruded LCP coatings, we have demonstrated that thinly extruded LCP can exhibit tensile modulus and strength many times greater than the values given above.

4. Results of Qualification Testing

We conducted qualification testing as per European Space Components Coordination (ESCC) Specification No. 2263010 for fiber connector sets. We tested 50 μm, graded index multimode fiber patchcords with AVIM/APC connectors on one end and FC/UPC connectors on the other (Figure 9).



Figure 9. Test samples used for qualification

4.1. Optical Insertion Loss (IL)

Insertion loss (IL) of the connectors is the first critical test and the requirement is for IL < 0.2 dB where IL is defined as loss through two mated AVIM/APC connectors. This is a stringent requirement. Typical tolerances in connector sleeves coupled with fiber dimension tolerances results in IL < 0.4 dB. See, for example, Telcordia Technologies Generic Requirements, GR-326-CORE. Of 30 mated AVIM/APC connector pairs tested only 17 passed this test. On the other hand if IL requirement is relaxed to 0.4 dB, 29 pairs would have passed. Inherent tolerances in connector parts

and in the polishing process such as undercut, radius of curvature (ROC) and dome offset (Apex) imply that the only way to get IL < 0.2 dB is to down-select from finished patchcords which doubles the cost.

The effect of connector end-face geometry is summarized in Table 1. It appears that the most significant difference in failed and passing assemblies is in the undercut. Because of the soft metal insert used in AVIM connector ferrules vs. a standard ceramic ferrule the fiber tends to protrude.

Table 5. Connector IL dependence on end-face geometry

	Ratio of st. dev./ average		
	ROC	Undercut/Protrusion	Apex
All assemblies	0.10	0.18	0.41
Passing Assemblies	0.08	0.15	0.40
Failed Assemblies	0.14	0.25	0.37

4.2. Other qualification tests

Other tests performed and a summary of results are listed in Table 6

Table 6. Qualification tests performed as per (ESCC) Specification No. 2263010

Test	No. of patchcords tested	Results of test
High temp stress test (5 hr. at 120 ⁰ C)	2	Passed
Low temp stress test (5 hr. at -70 ⁰ C)	2	Passed
Impact test	2	Passed
Torsion test	2	Passed
Side static load	2	Passed
Tension test	2	Passed up to tension of 25 N
Strength of coupling mechanism	1	Passed
Mechanical shock	2	Passes
Vibration test	2	Passed
Thermal cycle	6	4/6 passed
Rapid change of temperature	2	Passed
Salt mist	2	Passed
Rapid depressurization	2	Passed
Mating durability over 500 mating cycles	2	Failed because threads on mating adapter wore out
Temperature life	4	2/3 passed

5. Discussion of selected tests

For most of the tests Insertion Loss (IL) must be < 0.2 dB and Return Loss (RL) must be > 40 dB before and after the test, and change in transmittance (CIT) must not exceed 0.3 dB during the test.

5.1. High and low temperature stress test

Cables are tested at temperature extremes of 120⁰ C and -70⁰ C for 5 hours. Of two assemblies tested one assembly (S2 made with connectors C3 and C4) failed CIT during 5 hr. soak at 110⁰ C and 120⁰ C. Connector endface details for the two tested assemblies are shown in Table 1.

Table 7. Details of assemblies tested for temperature stress

Assembly	Patchcord Assembly	ROC	Undercut	Dome Offset
		5-12 mm	< 100 nm	< 50 μm
S1 - passed	C1	11.06	413	79.82
	C2	13.82	222	40.73
S2 - failed	C3	12.87	242	103.82
	C4	14.20	237	133.32

Comparison shows that the failed assembly had significantly higher dome offset which may,

therefore, be a critical element in achieving better temperature performance.

5.2. Temperature life test

Four assemblies are exposed to a temperature extreme of 85°C for 2000 hours. One assembly failed CIT. Connector analysis is in 0.

Table 8. Assemblies tested for temperature cycle

Assembly	Patchcord Assembly	Connector Type	ROC	Undercut/Protrusion	Dome Offset
			5-12 mm	< 100 nm	< 50 μm
S20 - passed	C39	AVIM/APC	14.19	255	51.13
	C40	AVIM/APC	10.99	421	79.61
S21- failed CIT	C53	AVIM/APC	11.43	402	69.93
	C54	AVIM/APC	12.71	344	71.00
S22 - passed	C43	AVIM/APC	11.94	448	50.58
	C45	AVIM/APC	13.34	218	59.29
S23 - passed	C55	AVIM/APC	11.57	380	33.57
	C56	AVIM/APC	10.23	440	69.89

Again we see that, while all assemblies had fairly high protrusion, the failed assembly had high dome offset for both connectors. It appears that dome offset may be the parameter that needs to be improved or selected against to improve performance on temperature related tests.

5.3. Thermal Cycle

This may be the most stringent temperature test. Six assemblies are cycled from -400 C to 85° C for a total of 100 cycles. Dwell time at temperature

extremes is 0.75 hr. CIT as a function of time is shown in Figure 10. Two out of six assemblies failed CIT. Note that connector pairs that failed seem to do so within the first 10 cycles. Also one of the failed samples shows CIT oscillation in sync with the temperature cycles. This is indicative of pistoning of the fiber in the ferrule resulting in a temperature dependent Fabry Perot effect. This can be improved by lower protrusion and higher temperature curing of the epoxy.

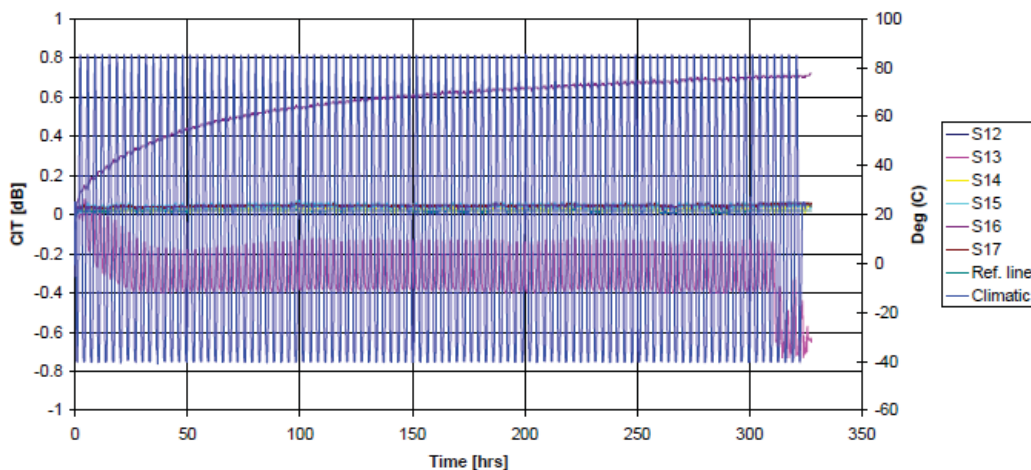

Figure 10. Change in Transmittance vs Climatic Data for Thermal Cycle

5.4. Radiation testing

This test was performed independently of the ESCC Specification No. 2263010 testing by one of our customers. They tested patchcords to 20 MRad. The Relative Optical Power [dB] was measured before irradiation and after 5 MRad, 10 MRad, and 20 Mrad as intermediate measurement

points. Then the patchcords were measured again after 24 hours and after one week annealing at

room temperature. All patchcords with AVIM-connectors do not show noticeable attenuation increase up to 20 Mrad total dose and can be used

in environments that are subjected to this level of total dose.

5.5. Outgassing

In June of 2012, NASA tested Linden's RAVNOC cable (p/n: 1-3-8-10-30-J-12.5-55-GRN). Values for the inner and outer jacket are as follows:

Outer Jacket:

Average Value TML (total mass loss): 0.01%

Average Value WVR (water vapor regain): 0.01%

Average Value CVCM (collected volatile condensable materials): 0.00%

Inner Jacket:

Average Value TML: 0.06%

Average Value WVR: 0.02%

Average Value CVCM: 0.01%

6. Conclusions

In conclusion,

- a. LCP coated optical fiber because of low out-gassing excellent tensile properties that do not degrade after radiation exposure is an ideal candidate for space applications.
- b. Patchcords with AVIM connectors passed most tests. However, polishing techniques need to be fine tuned to meet more stringent undercut and dome offset specifications.

REFERENCES:

De Jonge, et al, 2008. "Optical Absorption in Commercial Single Mode Optical Fibers in a High Energy Physics Radiation Field." IEEE Trans. On Nuclear Science, V55, No. 4, pp. 2216-2222

Aikawa, K., et al, 2008. "Radiation Resistant Single-Mode Optical Fibers." Fujikura Technical Review, 2008