

# International Conference on Space Optics—ICSO 2010

Rhodes Island, Greece

4–8 October 2010

*Edited by Errico Armandillo, Bruno Cugny,  
and Nikos Karafolas*

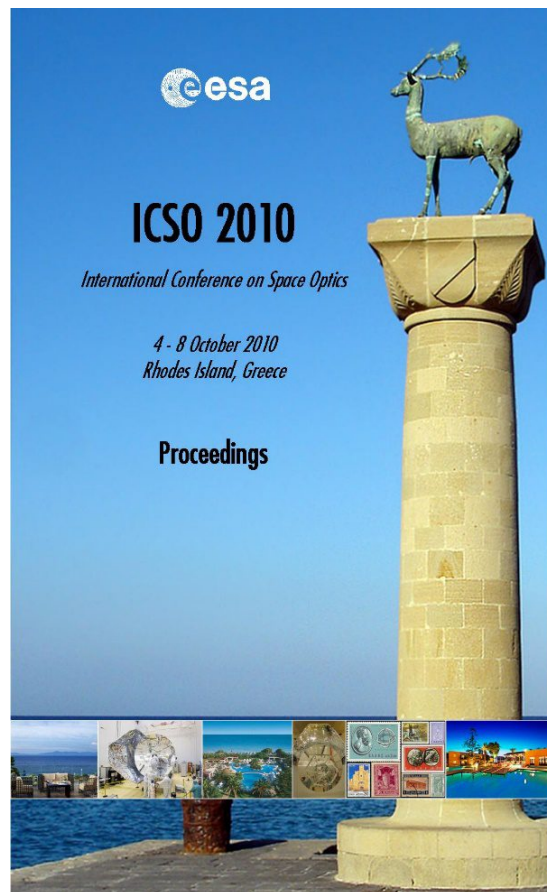

## ***Integrated optics for nulling interferometry in the thermal infrared: progress and recent achievements***

*M. Barillot, E. Barthelemy, L. Bastard, J.-E. Broquin, et al.*



International Conference on Space Optics — ICSO 2010, edited by Errico Armandillo, Bruno Cugny,  
Nikos Karafolas, Proc. of SPIE Vol. 10565, 105650Y · © 2010 ESA and CNES  
CCC code: 0277-786X/17/\$18 · doi: 10.1117/12.2309134

## INTEGRATED OPTICS FOR NULLING INTERFEROMETRY IN THE THERMAL INFRARED: PROGRESS AND RECENT ACHIEVEMENTS

M. Barillot<sup>1</sup>, E. Barthelemy<sup>2</sup>, L. Bastard<sup>3</sup>, J.E. Broquin<sup>3</sup>, G. Hawkins<sup>4</sup>, V. Kirschner<sup>5</sup>,  
S. Ménard<sup>1</sup>, G. Parent<sup>6</sup>, C. Poinsot<sup>1</sup>, A. Pradel<sup>2</sup>, C. Vigreux<sup>2</sup>, S. Zhang<sup>7</sup>, X. Zhang<sup>7</sup>  
<sup>1</sup>Thales Alenia Space, France. <sup>2</sup>Université de Montpellier-ICGM, France. <sup>3</sup>IMEP-LAHC, France,  
<sup>4</sup>University of Reading, UK. <sup>5</sup>European Space Agency, The Netherlands.  
<sup>6</sup>Université de Nancy-Lorraine-LEMTA, France. <sup>7</sup> Université de Rennes-LVC, France

### I. INTRODUCTION

The search for Earth-like exoplanets, orbiting in the habitable zone of stars other than our Sun and showing biological activity, is one of the most exciting and challenging quests of the present time. Nulling interferometry from space, in the thermal infrared, appears as a promising candidate technique for the task of directly observing extra-solar planets. It has been studied for about 10 years by ESA and NASA in the framework of the Darwin and TPF-I missions respectively [1].

Nevertheless, nulling interferometry in the thermal infrared remains a technological challenge at several levels. Among them, the development of the "modal filter" function is mandatory for the filtering of the wavefronts in adequacy with the objective of rejecting the central star flux to an efficiency of about  $10^5$ . Modal filtering [2] takes benefit of the capability of single-mode waveguides to transmit a single amplitude function, to eliminate virtually any perturbation of the interfering wavefronts, thus making very high rejection ratios possible.

The modal filter may either be based on single-mode Integrated Optics (IO) and/or Fiber Optics. In this paper, we focus on IO, and more specifically on the progress of the on-going "Integrated Optics" activity of the European Space Agency.

### II. BACKGROUND

A presentation of the Integrated Optics project can be found in [3]. Here we briefly recall the principles of Integrated Optics and our main technical goals.

Integrated Optics is about fabricating light-guiding structures in transparent material(s), similar in essence to optical fibres but made by different technological means. On top of single-mode filtering of the wavefronts, attractive specific features may be designed. For examples, optical functions such as beam combiners, or reduction of straylight, which in conventional optical fibres is transmitted by the so-called "cladding modes".

Etching high-index chalcogenide layers deposited on chalcogenide substrates represents our selected baseline technology. The main fabrication steps rely on photolithography and are illustrated in Fig. 1.

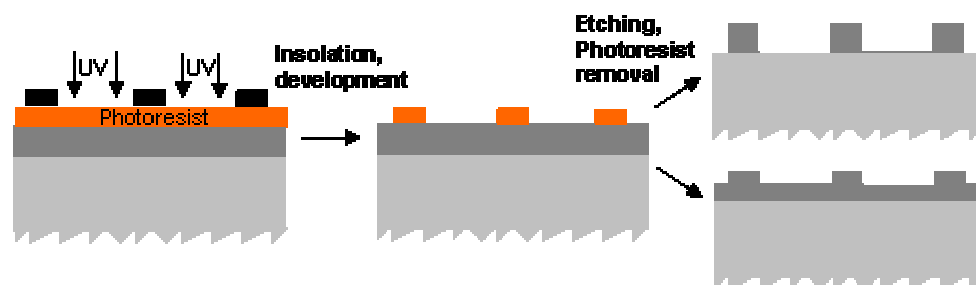

Fig. 1. Fabricating IO samples by etching optical material layers

In order to perform efficiently as modal filters in a nulling interferometer for extra-solar planet direct observation, our IO components are required to:

- Provide single-mode propagation solutions for both [6, 11 $\mu$ m] and [10,20 $\mu$ m] spectral bands.
- Attenuate less than 3dB attenuation by internal losses.
- Perform modal filtering efficiently, with preliminary goal of  $10^{-3}$  rejection.
- In addition, the IO components should avoid straylight and not be polarising.

### III. DESIGN, MODELLING AND PERFORMANCE PREDICTIONS

#### A. Design

Two families of IO designs are under investigations (Fig. 2). “Rib” waveguides avoid the need for a “superstrate layer”, while coupling light into “embedded strip” waveguides is more tolerant to the component’s edge geometry. Depositing anti-reflective coatings is also more straightforward with embedded strip designs.

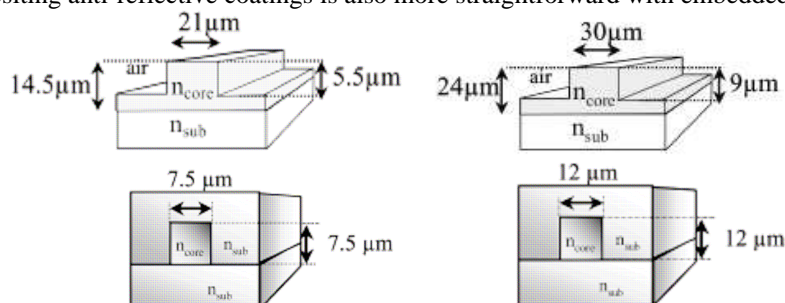
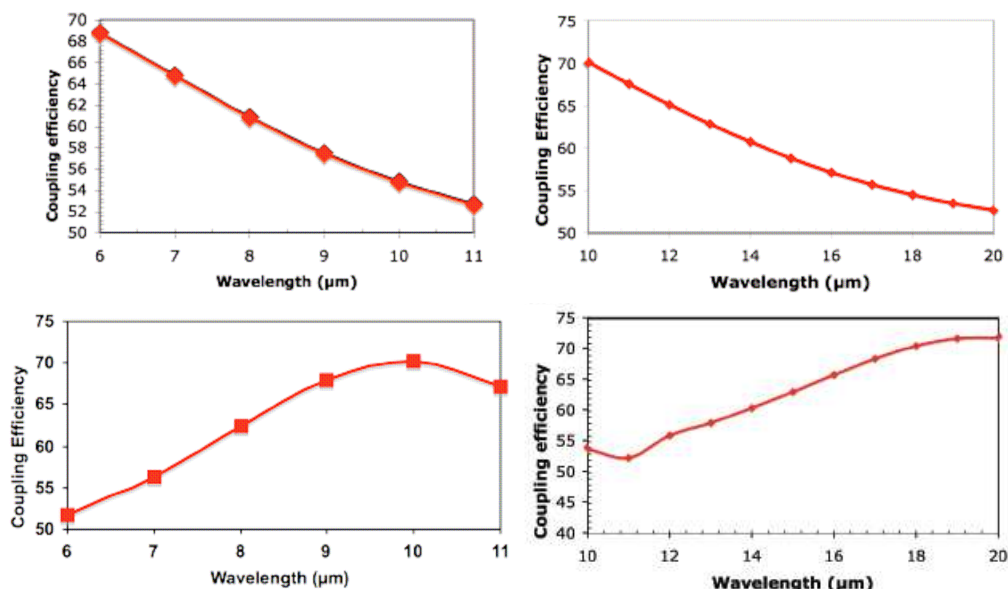

**Fig. 2.** “Rib” (top) and “embedded strip” (bottom) IO designs for [6,11μm] (left) and [10,20μm] (right)

The refractive index difference between the high-index “core” structure and the low-index substrate/superstrate, a critical parameter, is closely linked to the aperture of the coupling and collecting optics. By contrast to optical fibres, IO technology encourages the selection of relatively strong index differences, in particular because modal filtering efficiency is expected to be achieved along shorter propagation lengths with stronger guiding. However, the aperture of coupling optics must remain reasonable and was fixed at a  $f\#$  of 1.

#### B. Power transmission efficiency

Performance predictions are based on dedicated Beam Propagation Method models. Note that while the average coupling efficiency is similar to the one of optical fibres, the spectral behaviour of the coupling efficiency is quite different due to stronger guiding and different boundary conditions. The results are shown in Fig. 3. Theoretically, slightly better and more uniform performance can be computed; however we have preferred more robust designs, which include margins for technological tolerances and uncertainties.



**Fig. 3.** Coupling efficiency of our designs in % (figure arranged as Fig. 2)

#### C. Modal filtering efficiency

From [4], we define modal filtering efficiency as the output power ratio for anti-symmetric over symmetric excitations. Such excitations can be numerically and experimentally implemented from respectively destructive and constructive interference.

Our computations demonstrate that a 4cm propagation length, compatible with our fabrication capabilities, is enough to provide ratios of a few  $10^{-6}$ .

#### D. Polarisation

The present designs show negligible differences between the propagation constants of the main polarisation directions. Note that birefringent designs can also be produced if required.

### IV. TECHNOLOGICAL DEVELOPMENTS

The fabrication of the devices shown in the previous subsections involves a sequence of large number of elementary technological steps. At the beginning of the present study, some of them had been preliminarily investigated using samples made of more usual material, while the others were to develop from the beginning, with no reference in the literature to our knowledge. Our project therefore dedicated most of its effort to technological development. The progress status of the main technological issues we have tackled in the course of the project is summarised in Table 1.

**Table 1.** Technological progress overview

Technological issues	Status	Comments
Substrate homogeneity	√	Fully amorphous and homogeneous
Substrate stability	√	Index stable within measurement tolerance
Substrate transmission	√	Typically < 1dB per cm losses over [6-19μm] ; limited by measurement
Substrate dimensions	√	Successful 50mm diameter fabrication
Substrate polishing	√	Soft and brittle material, comparable to other infrared glass
Layer composition	√	Refractive index adjustable with Te/Ge proportions, may exceed that of substrate, controlled to $< 10^{-2}$
Layer stability	√	Index stable within measurement tolerance ( $10^{-3}$ )
Layer adhesion	√	Always excellent
Layer thickness	√	Thickness > 15μm per evaporation run
Layer homogeneity	√	Excellent stability of deposition parameters
Layer etching	√	See Fig. 4
Layer stacking	√	54μm thickness achieved in 4 runs
Superstrate stacking on etched structures	In progress	Best results with trapezoidal etching
Polishing	In progress	Current polishing procedure preserves etched structures and component edge. Resulting surface roughness improvement on-going
Anti-reflective coatings	In progress	Efficient (>90% two-sides) and stable solutions found. Investigation of behaviour close to the edge of the component is on-going.
Burying fibres cores into substrate	√	Performances to be tested

To detail every fabrication step would largely exceed the scope of the present paper. However we wish to mention the following comments, which complement Table 1.

The transmission domain of chalcogenide glasses is often said to be limited to a maximum of 12-14μm. Actually this statement is only valid for Arsenic- or Selenium-based materials, which indeed constitute the bulk of commercially available chalcogenide glasses. The use of the heavier Tellurium element extends the range towards the long wavelengths. Our preferred  $\text{Te}_{75}\text{Ge}_{15}\text{Ga}_{10}$  transmits very well up to 19μm and is still reasonably transparent at 20μm. TeI may even go deeper in the infra-red and reach 25μm.

The selection of co-evaporation for layer fabrication, i.e. simultaneous evaporation of the elementary constituents of the layer, is a key for the success of the present developments. This complex technique is the only one which gives access to enough parameters to control the properties of the fabricated layer with sufficient accuracy and stability.

Layer etching and stacking also involve a large set of parameters to be adjusted. Recent prototype views are shown in Fig. 4. While the complete testing of the components remains to be done, the Electron beam view provide encouraging information regarding the uniformity and homogeneity of the components.

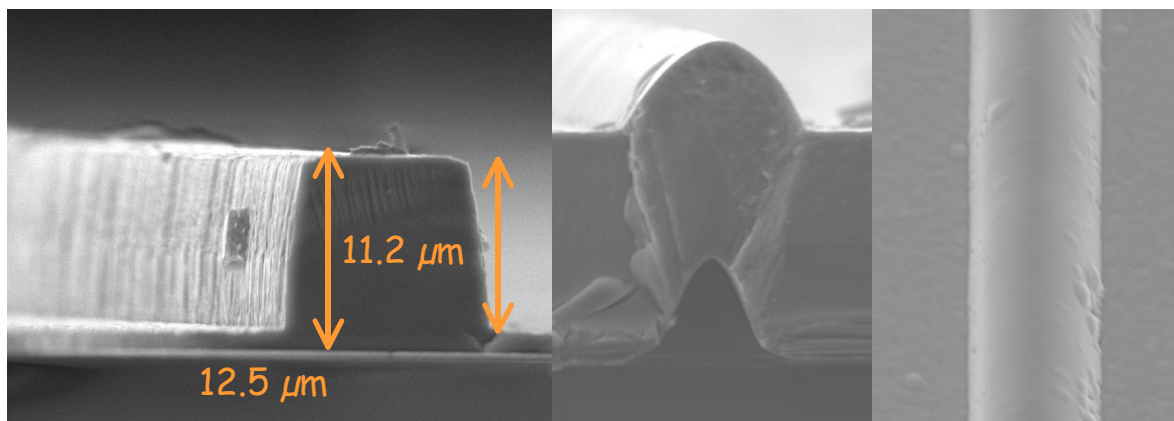
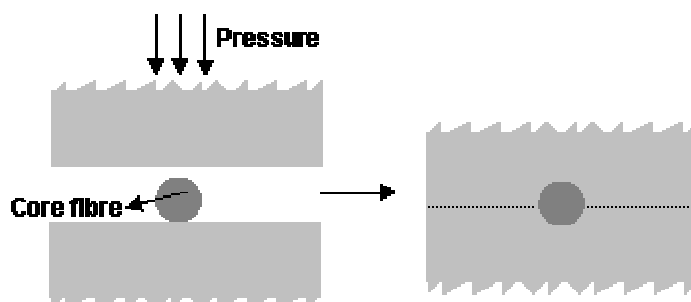

**Fig. 4.** Electron Microscope views of etched rib waveguide (left), superstrate covered strip waveguide with trapezoidal profile (center), top view of the superstrate (right)

Polishing happened to be a quite delicate issue not only due to the soft and brittle nature of the material, which is common among infrared glasses, but also the specific nature of integrated optics: the component edges and the etched structures must be preserved during the polishing operation. These requirements are somewhat relaxed for the embedded strip waveguide solutions, since field propagation occurs deeper into the component and is thus less sensitive to surface finish considerations. At present the polishing procedure allows the fabrication of efficient guides, while the quantitative evaluation of the roughness and possible associated losses remains to be evaluated.

Efficient anti-reflective solutions were found for both [6,11μm] and [10,20μm] spectral bands. The stability of the coatings is satisfactory despite the moderate T<sub>g</sub> temperature of the chalcogenide glass, which prevents anti-reflective coating deposition above typically 140°C. The location of the guides ends very close to the surface of the guide further complicates the process: roll-off of the coating towards the edge of the component and blow-by of coating material over the top surface of the component must be taken into account and are currently under study.

In parallel to the development of the baseline solution, etched chalcogenide layers on chalcogenide substrates, we are pursuing the development of an alternative technology: burying fibre cores into a chalcogenide substrate. This solution, which can be considered to be an intermediate between optical fibres and etched IO, offers several attractive features: for instance, the propagation occurs very deep into the component, which relaxes the tolerances on surface finish. Furthermore, by contrast to fibres, the low-index cladding has virtually unlimited dimensions, which may provide solutions to control straylight generated by the uncoupled/filtered-out power. However, the potential for implementation of optical functions is probably limited.



**Fig. 5.** Burying core-only fibers into a glass substrate

Currently several guiding prototypes have been produced, made of various materials such as e.g. GASIR fibres buried in As<sub>2</sub>S<sub>3</sub> or other similar materials. The core diameter was successfully reduced to typically 15 μm, theoretically enabling single-mode guiding. These components are about to be evaluated experimentally.



## V. EXPERIMENTAL RESULTS

Three main test benches were specifically developed for the Integrated Optics activity: a “m-lines” setup for layer refractive index measurement, a large spectral range Fourier Transform Spectrometer (FTS) and a single-mode interferometer with radiometric and polarisation capabilities.

The m-lines bench<sup>3</sup> now operates in routine mode. It shows adequate accuracy and repeatability, of about  $10^{-3}$ .

The FTS produced the first demonstration of light guiding in an infrared slab waveguide (i.e. guiding layer without etched structure) in the  $[6,20\mu\text{m}]$  spectral band, as illustrated in Fig. 6. The FTS is currently upgraded for the characterisation of guiding structures.

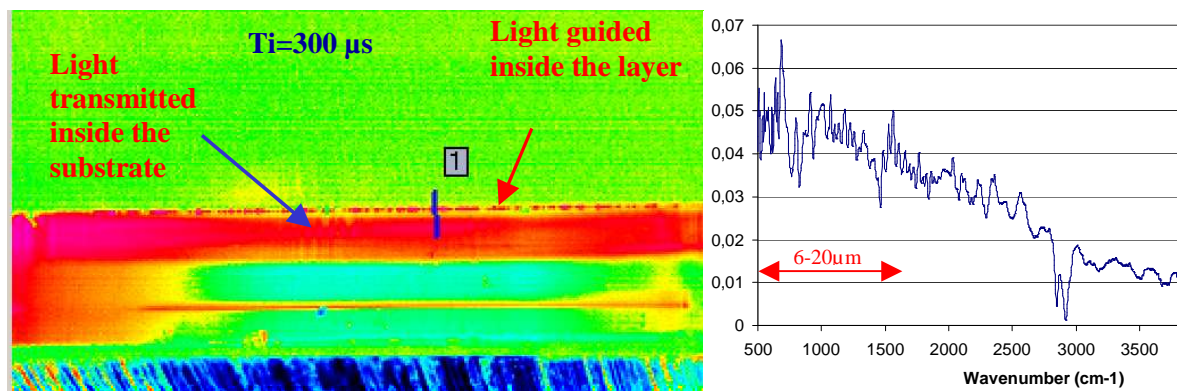

**Fig. 6.** First observation of light guiding up to  $20\mu\text{m}$  ( $500\text{ cm}^{-1}$ ) in a chalcogenide on chalcogenide slab waveguide (left); measured spectrum (right; y-coordinate in arbitrary units)

The laser interferometry bench was developed recently and is shown in Fig. 7. It is powered by a CO<sub>2</sub> laser, whose  $10.6\mu\text{m}$  wavelength is compatible with both our spectral bands. Its main functions are a Mach-Zehnder interferometer, an injection stage where light is coupled into the sample and an intermediate image of the output spot allowing imaging of baffling or filtering of the guided mode.

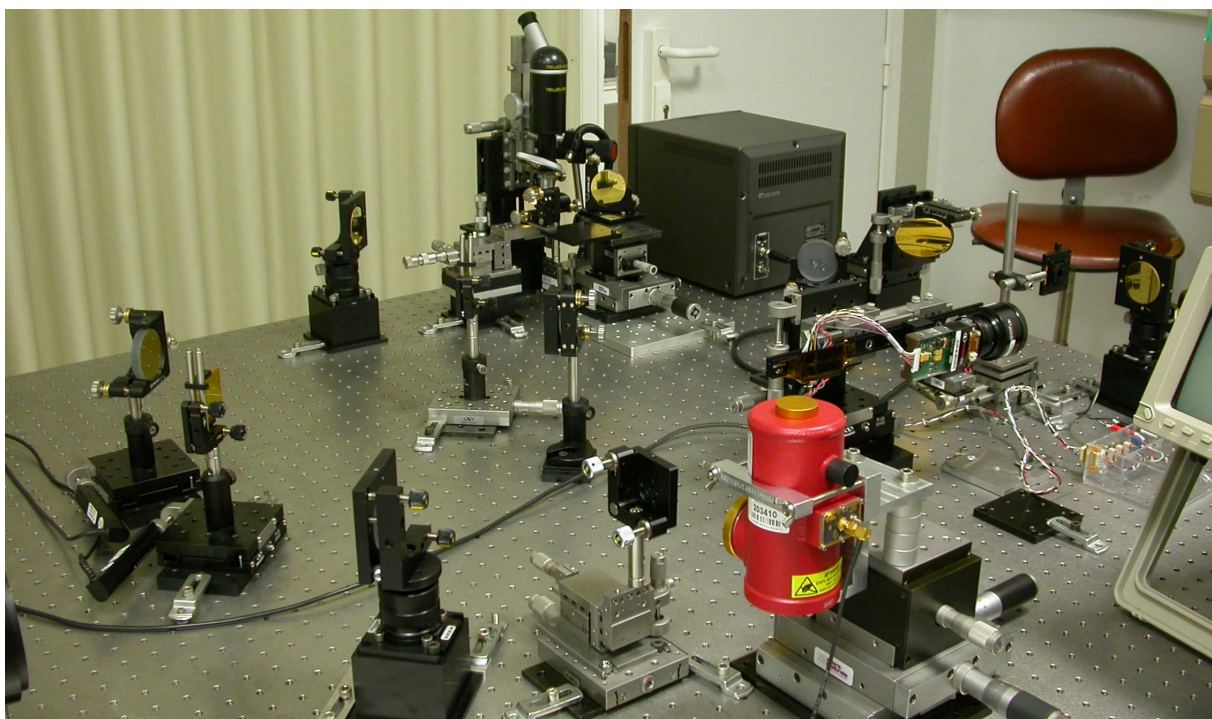

**Fig. 7.** Laser interferometry bench

Our main achievement to date was the measurement of the transmission efficiency of a rib waveguide prototype. A 1.7% transmission was obtained, to be compared with a prediction of max. 4.5%. This result shows that the sample losses due to surfaces finish and material losses do not exceed 4dB, only 1dB short of the 3dB objective, a very encouraging result for a preliminary measurement. The max. 4.5% transmission will be improved in the future, by playing on the surface finish of the sample, the homogeneity between the bench and component geometries, and by implementing anti-reflective coating on the sample.

The interferometric capability of the bench was just adjusted and is about to be tested on a sample. Here again the characterisation is planned to follow the principles established in ref<sup>4</sup>.

## VI. CONCLUSION

Valid technological solutions have been found for the fabrication of Integrated Optics modal filters in the [6,20 $\mu$ m] spectral band. Nearly all the associated procedures have been detailed, a few of them still requiring some investigations.

Prototype components have been produced and tested by means of dedicated benches. The results are quite encouraging regarding the spectral transmission range and the transmission efficiency.

The next step of the activity will focus on the production of upgraded samples with improved coupling efficiency, including anti-reflective coatings, and on the testing of the modal filtering efficiency by means of the interferometric capability of the laser bench, and of the spectral transmission efficiency of rib or strip guides by FTS. Later developments will aim at the manufacturing and tests of more complex components involving optical functions.

## ACKNOWLEDGEMENTS

Most of the challenges of the polishing issues were solved with the decisive help of Thierry Billeton, whom the authors wish to thank warmly. Eleonore Barthelemy's PhD thesis is funded by Centre National de la Recherche Scientifique and Thales Alenia Space.

## REFERENCES

- [1] M.C. Fridlund, "Darwin and TPF: technology and prospects", Proc. SPIE 5491, 227-235 (2004).
- [2] B. Mennesson, M. Ollivier and C. Ruilier, "On the use of single-mode waveguides to correct the optical defects of a nulling interferometer", J. Opt. Soc. Am. A 19, 596-602 (2002).
- [3] M. Barillot, E. Barthelemy, J.E. Broquin, J. Frayret, J. Grelin, G. Hawkins, V. Kirschner, G. Parent, A. Pradel, E. Rossi, C. Vigreux, S. Zhang and X. Zhang, "Integrated Optics for Nulling Interferometry in the Thermal Infrared", Proc. SPIE 7013, 701314 (2008)
- [4] A. Ksendzov, O. Lay, S. Martin, J.S. Sanghera, L.E. Busse, W.H. Kim, P.C. Pureza, V.Q. Nguyen. and I.D. Aggarwal, "Characterization of mid-infrared single mode fibers as modal filters", App. Opt. 46, 32, 7957-7962 (2007).