

# Journal of Astronomical Telescopes, Instruments, and Systems

AstronomicalTelescopes.SPIEDigitalLibrary.org

## Full-shell x-ray optics development at NASA Marshall Space Flight Center

Kiranmayee Kilaru  
Brian D. Ramsey  
Wayne H. Baumgartner  
Stephen D. Bongiorno  
David M. Broadway  
Patrick R. Champey  
Jacqueline M. Davis  
Stephen L. O'Dell  
Ronald F. Elsner  
Jessica A. Gaskin  
Samantha Johnson  
Jeffery K. Kolodziejczak  
Oliver J. Roberts  
Douglas A. Swartz  
Martin C. Weisskopf

Kiranmayee Kilaru, Brian D. Ramsey, Wayne H. Baumgartner, Stephen D. Bongiorno, David M. Broadway, Patrick R. Champey, Jacqueline M. Davis, Stephen L. O'Dell, Ronald F. Elsner, Jessica A. Gaskin, Samantha Johnson, Jeffery K. Kolodziejczak, Oliver J. Roberts, Douglas A. Swartz, Martin C. Weisskopf, "Full-shell x-ray optics development at NASA Marshall Space Flight Center," *J. Astron. Telesc. Instrum. Syst.* **5**(2), 021010 (2019), doi: 10.1117/1.JATIS.5.2.021010.

**SPIE.**

# Full-shell x-ray optics development at NASA Marshall Space Flight Center

Kiranmayee Kilaru,<sup>a,\*</sup> Brian D. Ramsey,<sup>b</sup> Wayne H. Baumgartner,<sup>b</sup> Stephen D. Bongiorno,<sup>b</sup> David M. Broadway,<sup>b</sup> Patrick R. Champey,<sup>b</sup> Jacqueline M. Davis,<sup>b</sup> Stephen L. O'Dell,<sup>b</sup> Ronald F. Elsner,<sup>b</sup> Jessica A. Gaskin,<sup>b</sup> Samantha Johnson,<sup>c</sup> Jeffery K. Kolodziejczak,<sup>b</sup> Oliver J. Roberts,<sup>a</sup> Douglas A. Swartz,<sup>a</sup> and Martin C. Weisskopf<sup>b</sup>

<sup>a</sup>Universities Space Research Association, Huntsville, Alabama, United States

<sup>b</sup>NASA Marshall Space Flight Center, Huntsville, Alabama, United States

<sup>c</sup>University of Alabama in Huntsville, Huntsville, Alabama, United States

**Abstract.** NASA's Marshall Space Flight Center (MSFC) maintains an active research program toward the development of high-resolution, lightweight, grazing-incidence x-ray optics to serve the needs of future x-ray astronomy missions such as Lynx. MSFC development efforts include both direct fabrication (diamond turning and deterministic computer-controlled polishing) of mirror shells and replication of mirror shells (from figured, polished mandrels). Both techniques produce full-circumference monolithic (primary + secondary) shells that share the advantages of inherent stability, ease of assembly, and low production cost. However, to achieve high-angular resolution, MSFC is exploring significant technology advances needed to control sources of figure error including fabrication- and coating-induced stresses and mounting-induced distortions. © The Authors. Published by SPIE under a Creative Commons Attribution 4.0 Unported License. Distribution or reproduction of this work in whole or in part requires full attribution of the original publication, including its DOI. [DOI: [10.1117/1.JATIS.5.2.021010](https://doi.org/10.1117/1.JATIS.5.2.021010)]

Keywords: x-ray telescopes; x-ray optics; full-shell replication; direct-fabrication; high-angular resolution x-ray mirrors; x-ray mirror fabrication.

Paper 18119SS received Nov. 27, 2018; accepted for publication Mar. 8, 2019; published online Apr. 5, 2019.

## 1 Introduction

Lynx is a concept for a future NASA flagship observatory operating in the x-ray energy range. The science objectives for Lynx<sup>1</sup> require an angular resolution of 0.5 arc sec half-power diameter (HPD) on axis and 2-m<sup>2</sup> effective area at 1 keV, with significant area throughout the 0.1- to 10-keV range. In x-rays, large effective collecting areas are achieved by closely nesting many grazing-incidence mirror shells in order to optimize the available aperture. Therefore, Lynx must use thin, lightweight mirrors to achieve a high degree of nesting and acceptably low mass.

The x-ray astronomy group at Marshall Space Flight Center (MSFC), among other research teams, has investigated various approaches to meet these technical challenges. Our high-resolution mirror development team envisions full-shell monolithic mirror elements fabricated from commonplace, lightweight, machinable metal, and metal alloy substrates. These materials combine low density and low coefficient of thermal expansion (CTE) with high-elastic modulus and high-yield strength. Together with monolithic full-shell construction, the MSFC design provides structural integrity throughout the fabrication process, system integration, launch, and operation over the mission lifetime.

This contribution to this special section presents current efforts in the MSFC x-ray optics group to develop high-resolution grazing-incidence mirrors and related technologies. The MSFC team continues to pursue our long-established nickel-cobalt replicated optics technology (Sec. 2) while also performing exploratory research into lightweight directly fabricated mirrors (Sec. 3) to meet the angular resolution and weight

challenges of Lynx. Figure 1 shows a flowchart showing the broad sequence of steps associated with the development of x-ray mirrors at MSFC for both replication and direct fabrication.

For thin lightweight mirrors, angular resolution is affected by internal stresses, coating-induced stresses, and mounting-induced distortions that cause medium- to large-scale figure errors. Therefore, in addition to exploring technologies to fabricate precisely figured thin shells, the team at MSFC is also pursuing capabilities to coat (Sec. 7) and to align and mount (Sec. 5) precisely formed mirrors including (static) postfabrication figure correction (Sec. 6) and associated metrology (Sec. 3.3).

## 2 Shell Replication

MSFC has more than two decades of experience in the development of grazing incidence x-ray optics through electroformed replication.<sup>2,3</sup> In this process, NiCo shells are replicated from a figured and super polished electroless-nickel-coated aluminum mandrel. The inside reflecting surface of a shell duplicates the high-quality figure of the outside surface of the mandrel. Many thin mirrors of varying diameter are nested into one module to increase the collection area. In the case of a multiple-module configuration where each nested module has its own focal plane such as for ART-XC (seven modules) or XMM-Newton (three modules), the replication has an advantage of producing multiple identical shells from a single mandrel. This leads to a significant decrease in the production cost, as most of the effort and development time is in mandrel fabrication and polishing. Figure 2 shows a photograph of a replicated shell on a mandrel coming out of the electroforming bath (a), a photograph of the mandrels (b), and shells of decreasing diameters (c).

\*Address all correspondence to Kiranmayee Kilaru, E-mail: [kiranmayee.kilaru-1@nasa.gov](mailto:kiranmayee.kilaru-1@nasa.gov)

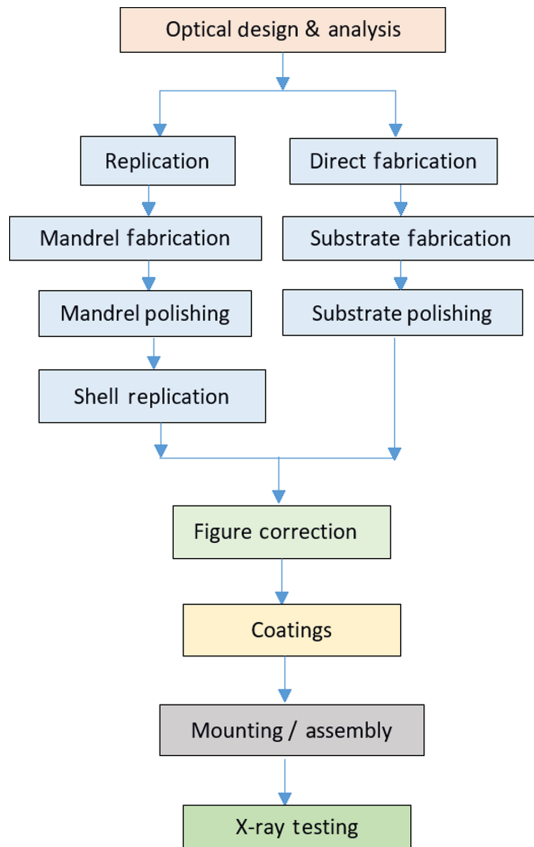

**Fig. 1** Flowchart showing the sequence of steps for x-ray mirror development.

The typical performance of mandrels fabricated at MSFC ranges from about 5 to 10 arc sec HPD; the typical shell performance is about 8 to 15 arc sec. Typically, the polishing process on the mandrel leaves mid-spatial frequency figure deviations, which then get replicated onto the mirror shell. The stresses involved with the replication process produce further deviations of the mirror shell profile from the mandrel profile.

Recent improvements achieved at MSFC in mandrel polishing demand investigation into the limitations of the electroformed

shell quality. Mandrel figure errors are transferred to replicated mirror shells as expected but additional, nonrepeatable, low-frequency distortions are also observed. These features must originate either during the electroforming process or during separation of the shell from the mandrel. The stresses induced in the electroforming process, which are a result of factors such as nonuniform electric field, are likely candidates for the cause of figure distortions. After electroforming, the mandrel, along with the replicated mirror shell, is cooled in a water bath, which promotes the shell to separate from the mandrel via the CTE mismatch of the aluminum mandrel and the NiCo shell. It is possible that the stresses from un-even separation of the shell from the mandrel can cause local microyielding of the shell material leading to low-frequency figure distortions. Plans are to perform a detailed investigation of the figure profile of shells replicated from a well-characterized mandrel, varying the electroforming and chemical separation parameters and possibly including instrumentation to monitor and quantify the stresses during the separation process. These experiments are ongoing and are expected to lead to a better understanding of the replication process that will help to minimize figure distortions, specifically at low spatial frequencies.

### 3 Direct Fabrication of Full-Shell Optics

The Chandra mirrors prove that direct polishing of lightweight stiff materials, such as glass, can result in sub-arc sec, resolution large-diameter x-ray optics. The MSFC direct fabrication development<sup>4</sup> for x-ray telescope optics aims to preserve the high angular resolution that can be achieved using traditional small-lap figuring and polishing techniques, while significantly reducing the thickness of the mirror shell to permit large effective areas for a given mirror-module diameter. The metal substrate materials will be diamond turned along the inner surface, heat treated to relieve residual stresses, then machined to  $<100 \mu\text{m}$  RMS. After this, electroless-nickel plating (a hard NiP alloy on which the final figuring and polishing will take place) will be done in three stages. The first stage involves plating the minimum thickness on the back surface with the front surface masked in order to compensate for plating stresses. Then the back surface will be masked and the front surface will be plated with thicker material to account for optical processing such as

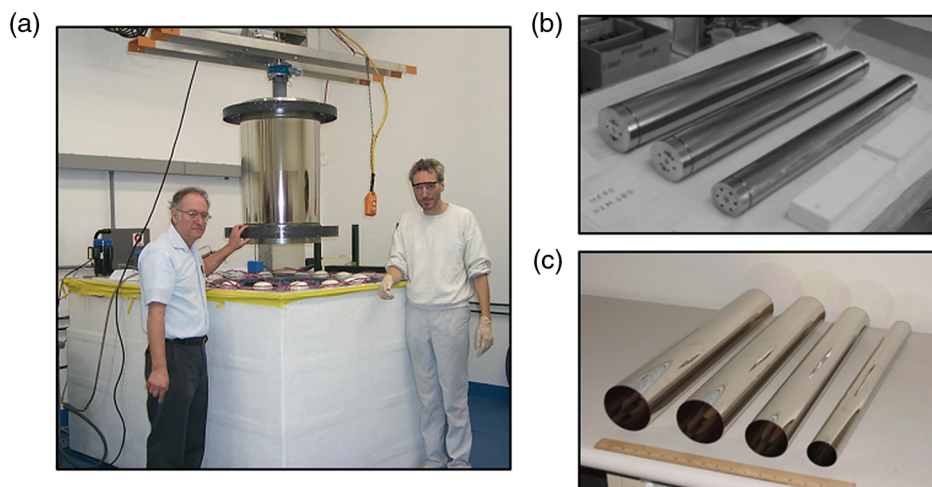

**Fig. 2** (a) The picture of a replicated shell coming out of the electroforming bath and photographs of (b) mandrels and (c) shells ranging in diameters of about 40 to 48 mm and length of about 600 mm.

grinding and polishing. Finally, the mirror reflecting (front) surface will be single-point diamond turned. The result will be a surface with a 1-to-2- $\mu\text{m}$  surface error, and a few 10 s of nm surface finish, as a starting point for polishing using a computer-controlled Zeeko IRP600X machine.

This process requires: (1) choosing an appropriate substrate material, (2) developing fixtures that adequately support thin shells during fabrication, and (3) developing *in situ* metrology to help reduce fabrication time in addition to refined polishing and figuring techniques.

### 3.1 Material Selection

Substrate materials for lightweight, thin-shell, x-ray optics should have low density, low CTE, high modulus of elasticity, and high working strength. Materials should also be easy to machine, figure, and polish. MSFC is analyzing metal and metal alloy substrate materials for full-shell x-ray optics. These materials improve the mechanical stability of the optics, reduce manufacturing costs by permitting single-point diamond turning to produce surfaces with desirable figures with extremely low out-of-roundness errors and low subsurface damage. When subsurface damage is low, less material must be removed during final surface figuring. Hence, mid-frequency surface errors, which are difficult to correct, are significantly reduced.

Materials under consideration at MSFC include Be, BeAl, Al, AlSi, and AlSi + SiC. Be and BeAl have the highest elastic moduli, lowest density and CTE, and moderate yield strength. The family of Al/Si materials also has low density, a CTE that can be tailored by varying the silicon content, and a high-yield strength that approaches the ultimate tensile strength with little-to-no plastic deformation. Silicon carbide provides further reduction of the CTE and increases elastic modulus.

These materials can be coated with NiP—the same material used for years at MSFC to coat Al mandrels—before machining and polishing. This is especially important when working with the high-toxicity materials Be and BeAl. These substrates can, therefore, be worked with near-standard machine processes. Large, high-quality components are routinely cast from these materials, making them readily available and relatively inexpensive.

An added advantage of the family of BeAl and AlSi materials is that the mirror-shell support structure can also be fabricated from the same material, simplifying the thermal design. Moreover the use of the metal alloys for the substrates permits fabrication of mounting flexures integral to the mirror for mounting the shell into the telescope structure, reducing the number of epoxy joints and thus producing more stable optics.

### 3.2 Backing Support Fixtures

For thin-shell fabrication, a major challenge is supporting the shell during processing. The integrity and the optical performance of the mirror need to be preserved during fabrication, metrology, and assembly by providing adequate support. Specifically, thin, lightweight shells must be supported during processing to prevent fracture or microyield and also to minimize deflection that would adversely affect the deterministic polishing. The current backing-support design consists of a stiff outer shell that provides all the support to the thin mirror and a thin layer of pliable backing/interface material that goes between the mirror shell and the outer support (see Fig. 3).

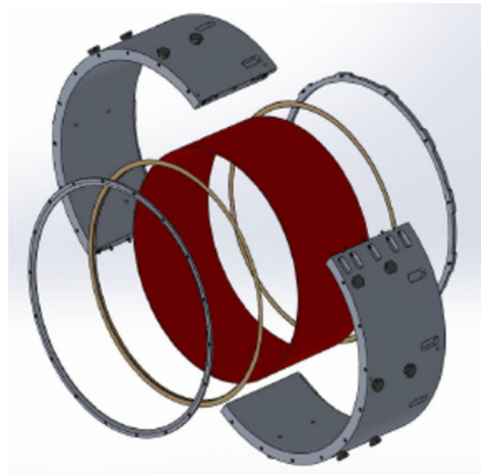

**Fig. 3** Design of a thin-shell backing support system for polishing. A thin layer of pliable backing material (not shown) acts as an interface between the mirror shell (red) and the stiff outer support clamshell (gray). The support rings and gaskets prevent the backing material from escaping. This system has been fabricated.

A gasket seals the system and prevents the backing material from escaping.

Initial studies were conducted using a range of high-viscosity liquid backing material. Several granular materials were also investigated including various sizes of spherical glass beads and sand of various grades. Finite-element simulations were used to assess stresses involved in the full-scale application of this shell-support technique. These simulations predicted Von Mises stresses and displacements for different combinations of mirror shell and support backing materials in the computer controlled (Zeeko) polishing environment. These simulations show that the uniform support provided by this fixture design results in ultra-low stresses, even for extremely thin shells, hence permitting a significant reduction of the shell thickness for direct fabrication. One-quarter-scale mechanical tests were conducted, which showed that sand performed best of all materials tested. The same fixture was used to demonstrate that this backing material can be uniformly distributed, thereby reducing hydrostatic-pressure-induced nonuniformities. Vibration can be used during the filling process to “compact” the sand for additional stiffness.

### 3.3 In Situ Metrology

*In situ* metrology is intended to dispense with the need for moving the test surface between fabrication and metrology stations, thus eliminating the time spent reinstalling and realigning after each metrology cycle. We note that about 1/3 of the time for fabricating the Chandra mirrors was spent moving mirror elements between fabrication and metrology stations. Performing metrology with the mirror shell in the fabrication configuration also helps to improve the working precision. *In situ* metrology under development at MSFC employs phase-measuring deflectometry (PMD),<sup>5</sup> where a projected fringe pattern is reflected from the mirror work surface onto an image recorder (see Fig. 4). Deviations from perfect spacing of the observed fringe pattern measured at multiple phases then provides an unambiguous measurement of deviations in the slope of the reflecting surface from its ideal shape. Deflectometry has several advantages: it is relatively insensitive to vibrations,



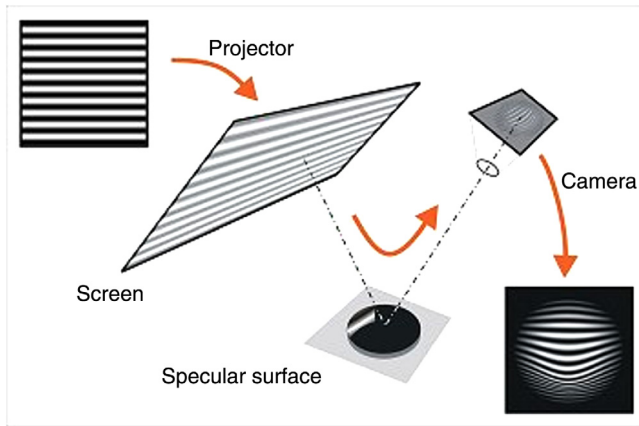

**Fig. 4** A projected fringe pattern is reflected from the mirror work surface onto an image recorder. Deviations from perfect spacing of the observed fringe pattern measured at multiple phases then provides an unambiguous measurement of deviations in the slope of the reflecting surface from its ideal shape. The positioning of the elements shown will be modified to accommodate the large diameter mirrors for the test surface.

immune to trace errors, and has no coherent noise. It is also very fast, as it does not involve mechanical scanning. Hence, many images can be averaged to reduce random noise. The PMD method is capable of nanometer resolution<sup>6</sup> when used for metrology of x-ray mirrors.<sup>7,8</sup> The technique can be used directly on diamond-turned surfaces<sup>9</sup> because it is also insensitive to the quality of the surface. PMD does not require the incidence (observation) angle to be normal to the test surface for the measurements. Therefore, the fringe-pattern projector and the imaging detector can be positioned outside the fabrication working area. The technique applies well to relatively larger diameter mirror such as proposed for lynx. The *in situ* metrology system at MSFC is currently at a low-technology readiness level (TRL) breadboard configuration. It is being used to optimize the relative positions of the working optic, the fringe projector (a computer monitor), and the reflected image detector (one of several optical cameras). The relative positions drive the surface slope measuring accuracy, the spatial midfrequency coverage, and the axial and azimuthal portions of the shell surface under the test.

## 4 Polishing

To achieve high-angular resolution, the figuring and polishing steps must be advanced to a high precision. For replicated optics, this means polishing the mandrel; for direct fabrication, polishing the optic itself.

### 4.1 Lap Polishing

Mandrels used in the electroformed replication process are made from an aluminum blank that is machined to the right dimensions. The blank is then coated with electroless nickel onto which the prescribed figure is diamond turned. The single-point diamond turning process produces a precise figure, but leaves residual tool marks. The lap polishing process is then aimed at removing these marks and other mid-spatial frequency figure errors, thereby producing a finely polished surface with  $\sim 0.5$ -nm roughness. The lap polishing process has greatly improved with each succeeding MSFC project from HERO (20 arc sec), ARTXC (15 arc sec), and FOXSI (10 arc sec) mandrel performance. For the current IXPE mandrels, there is

another factor of 2 improvement in the mandrel quality leading to 5-arc sec performance (for the mandrel itself). These improvements are a result of optimizing the parameter space of the lap-polishing process. In order to meet the sub-arc sec requirement, computer controlled polishing has to be adapted with *in situ* metrology and feedback control to enable both accuracy and efficiency. Apart from lap polishing, MSFC is also actively pursuing the use of computer controlled polishing for the mandrels.

### 4.2 Computer Controlled Polishing

MSFC has been developing a process for using a seven-axes-of-motion Zeeko IRP 600 robotic polisher, capable of polishing the inside of directly fabricated thin shells of 600-mm diameter and the external surface of vertically oriented cylindrical x-ray mandrels up to 500-mm length. The Zeeko polisher is capable of polishing to 1/10th wave peak-to-valley and is optimal specifically for the removal of mid-spatial-frequency figure errors. The Zeeko machine utilizes an inflated rubber hemispherical diaphragm, or “bonnet,” supporting a polishing medium. The bonnet is attached to a spindle that rotates and compresses to conform to the contour of the work surface. A large range of figure error spatial frequencies can be corrected by varying the material removal rate (determined by tool feedrate, bonnet pressure, spindle rotation rate, tool offset, precess angle, and bonnet angle), bonnet characteristics (radius, thickness, and elastic modulus), and slurry characteristics (particle grit size and solids fraction) (see Fig. 5). The advantage of such a process is that specific and unique features in a figure can be directly targeted and corrected. In addition, many different tools and slurry combinations can be employed for different tasks and goals.

The wear function dependence on these polishing parameters was determined through a series of test polishing runs performed on NiP-plated flat samples. This series of experiments was performed to develop and evaluate algorithms for applying the wear function for surface-error correction. After each polishing run, the surface figure was measured with an optical interferometer, a surface map produced, and the surface map used to validate the wear function model. After trying various constrained fitting and deconvolution algorithms, we found that a Richardson–Lucy deconvolution<sup>10,11</sup> leads to the best overall polishing performance for simulated postpolished slope errors. Using metrology data from the sample to be polished and these deconvolution algorithms, the software calculates the optimal tool path to reduce surface errors and generates the Zeeko-machine control code corresponding to the path. Using an optimal set of parameters and precise computer numerical control permits highly deterministic figuring of the surface at a higher convergence rate, when compared to traditional polishing machines.

The most recent application to NiP-coated vertically oriented cylindrical mandrels has met grazing-incidence prescriptions to within 0.5-arc sec slope error (corresponding to an HPD  $< 2$  arc sec) for spatial wavelength ranges  $\geq 7$  mm (a limit set by the current tooling). The wear function prediction typically agrees with the measured value to within a few nanometers; validating the well-controlled capabilities of the polishing process. The current best surface roughness resulting from this process is typically  $\sim 1.5$  to 2.0 nm with a goal of 0.5 nm or better. Figure 6 shows photographs of lap-polishing stations and the Zeeko polishing machine.

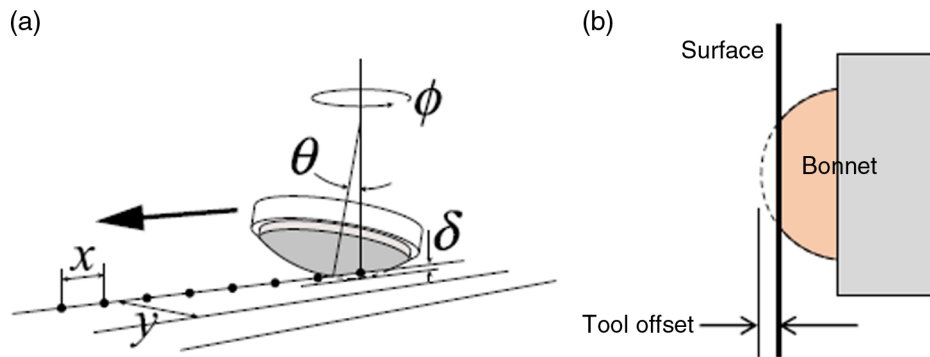

**Fig. 5** From Ref. 6 (a) Illustration of precess angle  $\theta$ , phi angle  $\phi$ , tool offset  $\delta$ , point spacing  $x$ , and track spacing  $y$ . Polishing bonnet (of about 40-mm radius) moves at specified feed rate between points spaced at  $x$  along tracks spaced at  $y$  and (b) tool offset.

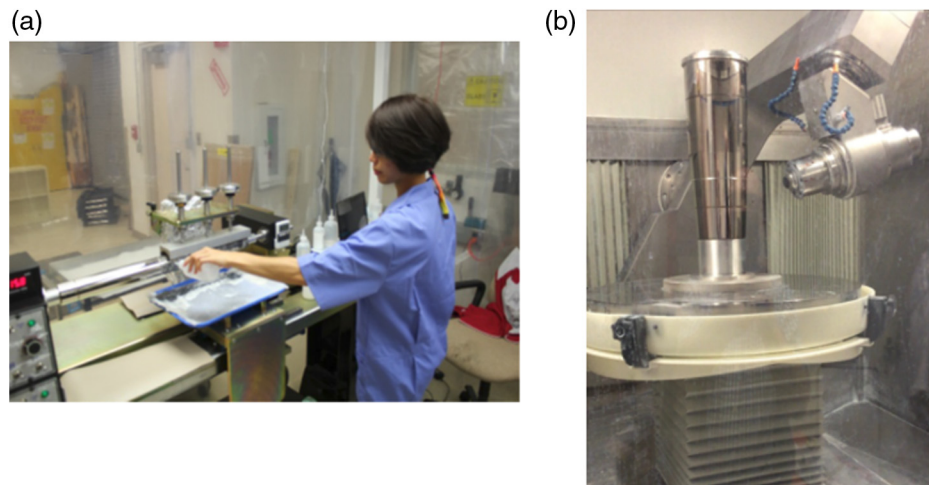

**Fig. 6** Photograph of mandrel at: (a) lap-polishing and (b) Zeeko polishing of vertically mounted mandrel (of about 140-mm in diameter and 600-mm in length).

## 5 Alignment and Assembly

An assembled module with multiple nested mirror shells typically has poorer performance than a single free-standing mirror shell, due to distortions induced by the mounting hardware in contact with the shell and also by epoxy shrinkage. Dedicated alignment stations [see Fig. 7(a)] are developed at MSFC for alignment and assembly of mirrors into a spider. The station consists of a base-plate assembly, a circularity-measurement system, a spider-support assembly, and a computer-controlled shell support and positioning system. The positioners, the controllers, and the measurement systems interface with the control computer. The base-plate assembly consists of a motorized rotary air-bearing table with a circular base plate. The metrology system consists of a sensor support stand with noncontact displacement Keyence sensors controlled by the computer. The shell support and positioning system consists of two motion-independent subsystems: an axial support system and a radial positioning system. The spider support assembly includes bottom and top spiders connected by the module column and the bottom spider positioning stages. Custom software has been developed to control the shell positioners and to collect and analyze the circularity data. Custom designed clips are also used as an interface between the mirror and the spider, which help to redirect distortions into the tangential direction.<sup>12</sup>

A specially designed hanging-wire approach is also being used for the alignment and assembly of current optics in order to offload stress [see Fig. 7(b)]. In this design, a mirror shell is held on one end by wires at nine different positions with actuation at three locations. The weight of the mirror is offset by counterweights at the six other locations. The actuation is performed vertically at the top of the wire using picomotors with a precision of about 30 nm. This configuration enables the mirror weight to be off-loaded at the bonding locations while the mirror is being aligned into the mount thus minimizing figure distortions imparted during the assembly process. Figure 7 shows photographs of the two different assembly stations used at MSFC.

## 6 Postfabrication Figure Correction

Differential deposition has proven to be a viable postfabrication figure-correction technique to improve the angular resolution of the x-ray mirrors. This technique involves depositing a varying amount of material (10s to 100s of nm) on the surface of the mirror shell, with the goal of minimizing the figure errors of spatial frequencies ranging from 1 to 10s of mm. The minimum amount of material that can be deposited is limited by the metrology accuracy while the maximum amount is dependent on the stress introduced by the deposited material and coating



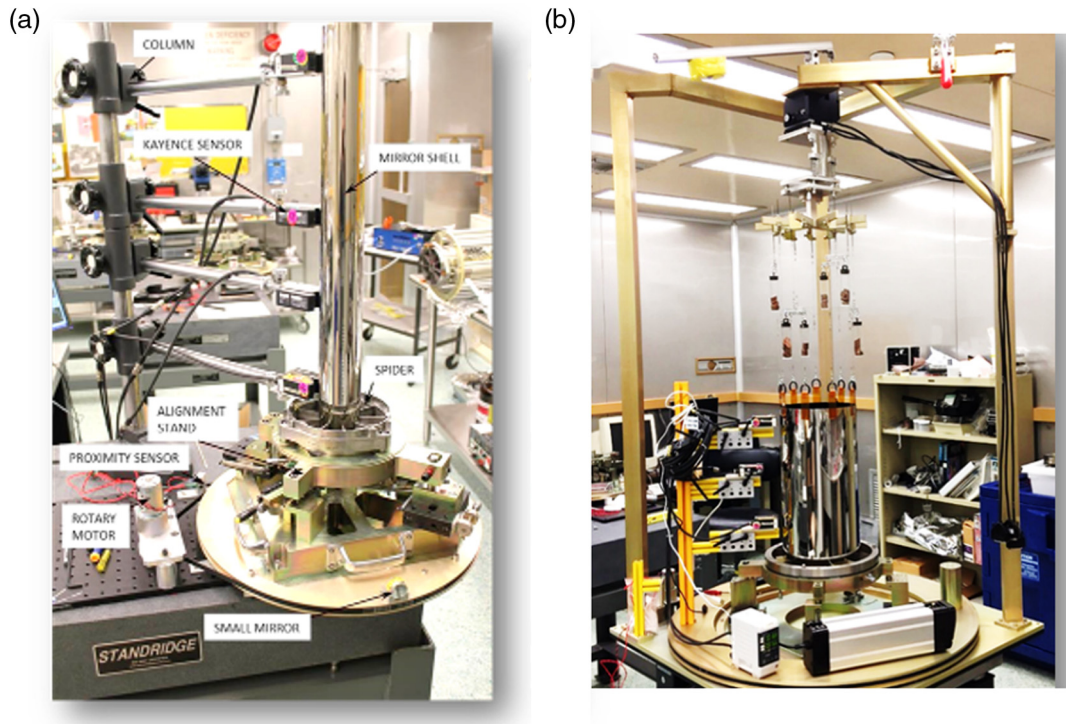

**Fig. 7** Photograph of two different alignment and assembly stations used at MSFC: (a) custom developed alignment station and (b) hanging wire approach. Shells range from about 130- to 140-mm in diameter and 600-mm in length.

properties such as adhesion and roughness. Custom developed vacuum chambers are utilized for the purpose with computer controlled translation and rotation stages. The coating parameters are optimized in order to minimize additional roughness ( $<0.6$  nm). In the past, an iterative approach was used to correct the broader surface features with higher amplitude first, followed by correction of progressively smaller features. A factor of 2 improvement has been demonstrated through x-ray testing, a factor of 3, through figure metrology.<sup>13</sup> Current efforts are focused on improving the efficiency of the process. One approach is to use active slits that can correct multiple spatial frequencies along an axial scan. The design of this slit has been completed and the required components are currently being procured. The second approach toward improving the efficiency of differential deposition is the use of a custom mask with varying hole sizes that can correct the entire mirror surface in a single round of coating without having to scan along multiple axial positions. The design of this mask has been completed and is currently being fabricated.

## 7 Coatings

A technological challenge associated with achieving high-angular-resolution optics is due to the stress in the thin film coatings that are deposited to enhance the x-ray reflectivity. The stress in the coating deforms the substrate's figure and can severely degrade the optic's imaging resolution. To help identify mechanisms for reducing the film stress, MSFC has developed an instrument for the *in situ* measurement of thin film stress.<sup>14</sup>

The device, shown in Fig. 8, utilizes a high-resolution fiber-optic displacement sensor (FODS) to measure the evolving displacement of the tip of a cantilever-substrate in real-time during film growth. The measured displacement is then geometrically

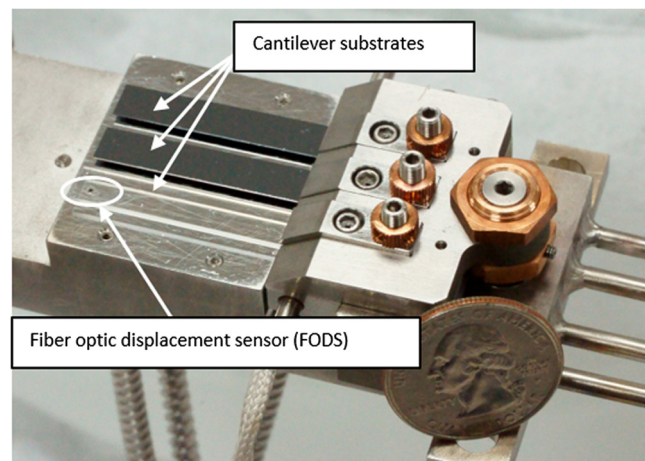

**Fig. 8** MSFC *in situ* stress measurement device shown with cantilever-substrate. Three substrates of either glass or crystalline silicon can be utilized simultaneously. The small fiber-optic sensor is visible under the glass substrate.

related to the substrate's curvature from which the stress is calculated according to the Stoney equation. The FODS can detect nanometer-scale displacements of the cantilever tip, which results in a detectable limit in the integrated film stress of 25 MPa nm. This means that a change in film thickness of 0.25 nm (or 2.5 Å) can be detected for a growing film with an intrinsic stress of only 100 MPa.

The device has helped identify and exploit the microstructural evolution in iridium films deposited by magnetron sputtering with argon process pressure (Fig. 9). With the aid of *in situ* stress measurement, we were quickly able to optimize

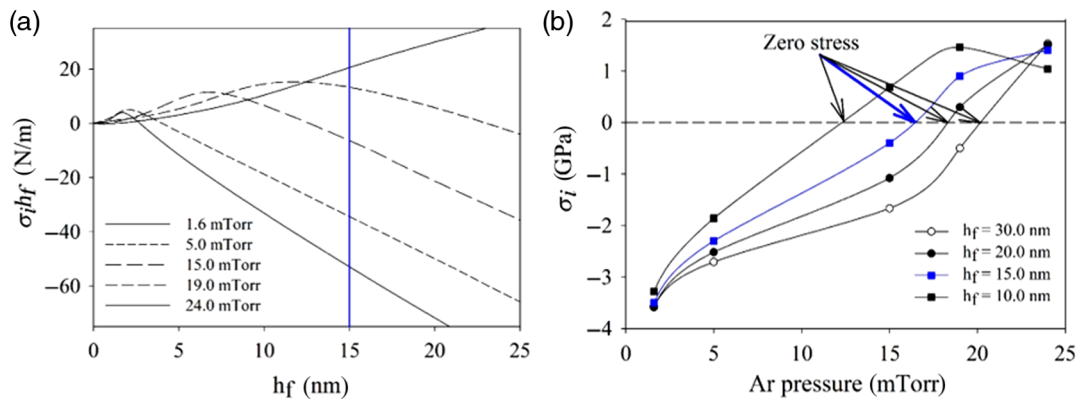

**Fig. 9** (a) The *in situ* stress in iridium films as a function of film thickness for the indicated argon process pressures and (b) the stress as a function of argon pressure for the indicated film thicknesses. The blue line indicates the stress for a 15-nm-thick iridium film and shows that zero stress occurs at 16.5 mTorr.

the argon pressure to achieve a stress reduction of nearly three orders of magnitude in iridium films, while also maintaining the surface roughness within acceptable limits for soft x-ray reflectivity.<sup>15</sup> The stress evolution in polycrystalline metal films, such as iridium, can be associated with various features of film growth including nucleation, island growth, and island coalescence. The film stress reaches a tensile maximum during coalescences and then passes through zero stress before reaching a compressive steady state. We can precisely identify, with the aid of *in situ* stress measurement, the moment at which the film stress passes through zero for a given process pressure—this instance is associated with a certain film thickness as illustrated in Fig. 9. For an iridium thickness of 15 nm (in blue)—a thickness sufficient for the Lynx mirrors—zero stress will occur at 16.5 mTorr.

MSFC is currently adapting this technology to measure the change in curvature of figured optics caused by film stress, and as a method of *in situ* metrology for figure correction.

We are also designing a deposition system that will allow coating deposition on a range of substrate types: optical segments, full shells, and mandrels.

## 8 Toward Large-Area Sub-Arc Sec X-Ray Optics for Lynx

The high-resolution optics development at MSFC is part of what is referred to as full-shell optics technology (as opposed to segmented optics) in the Lynx concept study. Independent research and development is being pursued at Italy's Brera Astronomical Observatory (Civitani et al.), using fused silica as an alternate substrate material for full-shell optics.

A preliminary optical prescription meeting the science requirements for Lynx has been provided to the Lynx study team by MSFC. This design envisions a 3-m diameter, 10-m focal length assembly of 319 mirror shells ranging in thickness from 1 to 3 mm, length from 4.3 to 25 cm (per surface). This design provides slightly over 2 m<sup>2</sup> of effective area at 1 keV when coated with 10-nm C over 40-nm Pt (slightly under 2 m<sup>2</sup> if coated with Ir) and a grasp over the field of view with better than 1-arc sec HPD in excess of the required 600 m<sup>2</sup> arc min<sup>2</sup>.

For the Lynx concept, the mirror technology needs to achieve a technology readiness level (TRL) 5 by project Phase A (planned for October 2024) and TRL 6 by PDR (August 2028). Currently, the optics technology is assessed at TRL 2.

Realizing TRL 3 will require improvements in all aspects of the fabrication process—including polishing, metrology, and postfabrication figuring. Further improvements in the backing support fixture and understanding the implications of various error contributions caused by transferring the mount from diamond turning to figuring and polishing to differential deposition are needed to achieve TRL 4. A design for a breadboard mount and demonstration of basic functionality will be required for shells of various representative diameters.

TRL 5 requires demonstration of alignment and integration of a mirror shell into a flight-like support structure and achieving a full-shell performance at 1.5 times the error allowance as verified through x-ray testing. Once the methods for alignment and integration into the backing fixture are satisfactorily determined, several shells of different diameters will be integrated and x-ray tested as a whole and subjected to appropriate operational thermal and vibrational environments, in order to bring the system to TRL 5.

TRL 6 will require that Lynx 0.5-arc sec angular resolution can be met using a flight-like mount and that scalability (multiple shells) has been demonstrated. The assembly must then be tested in a flight-like environment.

## References

1. J. A. Gaskin et al., "Lynx Mission concept status," *Proc. SPIE* **10397**, 103970S (2017).
2. B. D. Ramsey et al., "Development of hard x-ray optics at MSFC," *Proc. SPIE* **4851**, 631–638 (2003).
3. B. D. Ramsey, "Replicated nickel optics for the hard-x-ray region," *Exp. Astron.* **20**, 85–92 (2005).
4. M. Gubarev et al., "Development of a direct fabrication technique for full-shell x-ray optics," *Proc. SPIE* **9905**, 99051V (2016).
5. M. V. Gubarev et al., "Development of a deflectometer for accurate surface figure metrology," *Proc. SPIE* **9603**, 96031T (2015).
6. W. Juptner and T. Bothe, "Sub-nanometer resolution for the inspection of reflective surfaces using white light," *Proc. SPIE* **7405**, 740502 (2009).
7. P. Su et al., "Non-null full field x-ray mirror metrology using SCOTS: a reflection deflectometry approach," *Opt. Express* **20**, 12393–12406 (2012).
8. C. Röttinger et al., "Deflectometry for ultra precision machining—measuring without rechucking," in *Proc. DGAO*, Vol. **112**, p. P28 (2011).
9. M. J. Collon et al., "Design, fabrication, and characterization of silicon pore optics for ATHENA/IXO," *Proc. SPIE* **8147**, 81470D (2011).
10. L. B. Lucy, "An iterative technique for the rectification of observed distributions," *Astron. J.* **79**, 745 (1974).



11. W. H. Richardson, "Bayesian-based iterative method of image restoration," *J. Opt. Soc. Am.* **62**, 55–59 (1972).
12. M. Gubarev, B. Ramsey, and W. Arnold, "Alignment system for full-shell replicated x-ray mirrors," *Proc. SPIE* **7360**, 73600A (2009).
13. K. Kilaru et al., "Improving x-ray optics via differential deposition," *Proc. SPIE* **10399**, 103991F (2017).
14. D. M. Broadway, "Mechanical stress measurement during thin film fabrication," US Patent 9601391, Granted (2017).
15. D. M. Broadway et al., "Achieving zero stress in iridium, chromium, and nickel thin films," *Proc. SPIE* **9510**, 95100E (2015).

**Kiranmayee Kilaru** received her PhD in optical science and engineering from the University of Alabama in Huntsville in 2010. She has been involved with x-ray optics for about 13 years. She is associated with the x-ray astronomy group of NASA MSFC. She has worked on the differential deposition technique for improving the figure of x-ray optics. Her current research interests include x-ray optics—design, fabrication, and testing, optical instrumentation, and coatings. X-ray optics development for various applications.

Biographies of the other authors are not available.